

JVC

SERVICE MANUAL

COLOUR TELEVISION

BASIC CHASSIS

CH

AV-21WH3 AV-21WX3 /A AV-21WS3 /AU AV-2178TEE

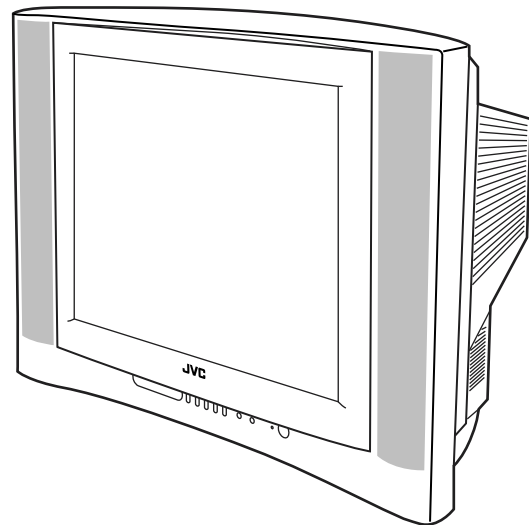

RM-C1011-1H
[AV-21WH3]

RM-C1010-1H
[AV-21WS3/AU]

RM-C1014-1H
[AV-21WX3/A]

RM-C1013-1H
[AV-2178TEE]

CONTENTS

- SPECIFICATIONS2
- OPERATING INSTRUCTIONS (APPENDIX)
- SAFETY PRECAUTIONS3
- FEATURES4
- FUNCTIONS5
- SPECIFIC SERVICE INSTRUCTIONS6
- SERVICE ADJUSTMENTS14
- STANDARD CIRCUIT DIAGRAM (APPENDIX) 2-1
- PARTS LIST39

SPECIFICATIONS

Items		Contents			
		AV-21WH3	AV-21WS3/AU	AV-21WX3/A	AV-2178TEE
Dimensions (W × H × D)		64.9cm x 46.55cm x 47.15cm			
Mass		22.5kg			
TV RF System		B, G, I, D, K, K1, M			
Colour System	TV Mode	PAL / SECAM / NTSC3.58 / NTSC4.43			
	VIDEO Mode	PAL / SECAM / NTSC3.58 / NTSC4.43			
Stereo System		A2 / NICAM (B/G, I, D/K) system		Playback only	
Receiving Frequency	VHF (VL)	46.25MHz – 140.25MHz (AS0 – S6)			
	VHF (VH)	147.25MHz – 423.25MHz (S7 – S36)			
	UHF	431.25MHz – 863.25MHz (S37 – C 57)			
	CATV	● Cable TVs of Mid (X-Z, S1-S10) Super (S11-S20) & Hyper (S21-S41) bands receivable			
Intermediate Frequency	VIF Carrier	38.0MHz			
	SIF Carrier	31.45MHz (6.55MHz)		31.5MHz (6.5MHz)	
		31.75MHz (6.25MHz)		32.0MHz (6.0MHz)	
		32.15MHz (5.85MHz)		32.5MHz (5.5MHz)	
		32.26MHz (5.74MHz)		33.5MHz (4.5MHz)	
Colour Sub Carrier Frequency		PAL (4.43MHz), SECAM (4.40625MHz / 4.25MHz) NTSC (3.58MHz / 4.43MHz)			
Aerial Input Terminal		75Ω Unbalanced			
Power Input		AC110 – 240V, 50 / 60Hz			
Power Consumption		126W (Max.) / 81W (Avg.)			
Picture Tube		Visible size : 51 cm measured diagonally			
High Voltage		29.0kV ± 1.5kV (at cut-off in service mode)			
Speaker		6.5 x 13cm Oval type x2			
Audio Output		7W + 7W			
Video / Audio Input (1 / 2 / 3)		Video(1,3) : 1Vp-p, 75Ω (RCA pin jack) Audio(1,2,3) : 500mVrms (-4dBs), High Impedance (RCA pin jack) S-Video Input (Input 1 over) [AV-21WH3, AV-21WS3/AU] Y : 1Vp-p Positive (negative sync provided, when terminated with 75Ω) C : 0.286Vp-p (burst signal, when terminated with 75Ω) Component Input (Input 2) Y : 1Vp-p positive (negative sync provided, when terminated with 75Ω) Cb/CR : 0.7Vp-p 75Ω			
Video/Audio Output		1Vp-p, 75Ω (RCA pin jack) 500mVrms(-4dBs) Low impedance (400Hz when modulated 100%) (RCA pin jack)			
Headphone Jack		Stereo mini jack (3.5φ)			
Remote Control Unit		RM-C1011-1H	RM-C1010-1H	RM-C1014-1H	RM-C1013-1H
		(Battery size: AA/R06/UM-3 × 2)			

Design & specifications are subject to change without notice.

SAFETY PRECAUTIONS

- The design of this product contains special hardware, many circuits and components specially for safety purposes. For continued protection, no changes should be made to the original design unless authorized in writing by the manufacturer. Replacement parts must be identical to those used in the original circuits. Service should be performed by qualified personnel only.
- Alterations of the design or circuitry of the products should not be made. Any design alterations or additions will void the manufacturer's warranty and will further relieve the manufacturer of responsibility for personal injury or property damage resulting therefrom.
- Many electrical and mechanical parts in the products have special safety-related characteristics. These characteristics are often not evident from visual inspection nor can the protection afforded by them necessarily be obtained by using replacement components rated for higher voltage, wattage, etc. Replacement parts which have these special safety characteristics are identified in the parts list of Service manual. **Electrical components having such features are identified by shading on the schematics and by (Δ) on the parts list in Service manual.** The use of a substitute replacement which does not have the same safety characteristics as the recommended replacement part shown in the parts list of Service manual may cause shock, fire, or other hazards.
- Don't short between the LIVE side ground and ISOLATED (NEUTRAL) side ground or EARTH side ground when repairing.**
 Some model's power circuit is partly different in the GND. The difference of the GND is shown by the LIVE : (⊥) side GND, the ISOLATED (NEUTRAL) : (⊚) side GND and EARTH : (⊕) side GND. Don't short between the LIVE side GND and ISOLATED (NEUTRAL) side GND or EARTH side GND and never measure the LIVE side GND and ISOLATED (NEUTRAL) side GND or EARTH side GND at the same time with a measuring apparatus (oscilloscope etc.). If above note will not be kept, a fuse or any parts will be broken.
- If any repair has been made to the chassis, it is recommended that the B1 setting should be checked or adjusted (See ADJUSTMENT OF B1 POWER SUPPLY).
- The high voltage applied to the picture tube must conform with that specified in Service manual. Excessive high voltage can cause an increase in X-Ray emission, arcing and possible component damage, therefore operation under excessive high voltage conditions should be kept to a minimum, or should be prevented. If severe arcing occurs, remove the AC power immediately and determine the cause by visual inspection (incorrect installation, cracked or melted high voltage harness, poor soldering, etc.). To maintain the proper minimum level of soft X-Ray emission, components in the high voltage circuitry including the picture tube must be the exact replacements or alternatives approved by the manufacturer of the complete product.
- Do not check high voltage by drawing an arc. Use a high voltage meter or a high voltage probe with a VTVM. Discharge the picture tube before attempting meter connection, by connecting a clip lead to the ground frame and connecting the other end of the lead through a 10kΩ 2W resistor to the anode button.

- When service is required, observe the original lead dress. Extra precaution should be given to assure correct lead dress in the high voltage circuit area. Where a short circuit has occurred, those components that indicate evidence of overheating should be replaced. Always use the manufacturer's replacement components.

9. Isolation Check (Safety for Electrical Shock Hazard)

After re-assembling the product, always perform an isolation check on the exposed metal parts of the cabinet (antenna terminals, video/audio input and output terminals, Control knobs, metal cabinet, screw heads, earphone jack, control shafts, etc.) to be sure the product is safe to operate without danger of electrical shock.

(1) Dielectric Strength Test

The isolation between the AC primary circuit and all metal parts exposed to the user, particularly any exposed metal part having a return path to the chassis should withstand a voltage of 3000V AC (r.m.s.) for a period of one second.

(. . . Withstand a voltage of 1100V AC (r.m.s.) to an appliance rated up to 120V, and 3000V AC (r.m.s.) to an appliance rated 200V or more, for a period of one second.)

This method of test requires a test equipment not generally found in the service trade.

(2) Leakage Current Check

Plug the AC line cord directly into the AC outlet (do not use a line isolation transformer during this check.). Using a "Leakage Current Tester", measure the leakage current from each exposed metal part of the cabinet, particularly any exposed metal part having a return path to the chassis, to a known good earth ground (water pipe, etc.). Any leakage current must not exceed 0.5mA AC (r.m.s.).

However, in tropical area, this must not exceed 0.2mA AC (r.m.s.).

● Alternate Check Method

Plug the AC line cord directly into the AC outlet (do not use a line isolation transformer during this check.). Use an AC voltmeter having 1000 ohms per volt or more sensitivity in the following manner. Connect a 1500Ω 10W resistor paralleled by a 0.15μF AC-type capacitor between an exposed metal part and a known good earth ground (water pipe, etc.). Measure the AC voltage across the resistor with the AC voltmeter. Move the resistor connection to each exposed metal part, particularly any exposed metal part having a return path to the chassis, and measure the AC voltage across the resistor. Now, reverse the plug in the AC outlet and repeat each measurement. Any voltage measured must not exceed 0.75V AC (r.m.s.). This corresponds to 0.5mA AC (r.m.s.).

However, in tropical area, this must not exceed 0.3V AC (r.m.s.). This corresponds to 0.2mA AC (r.m.s.).

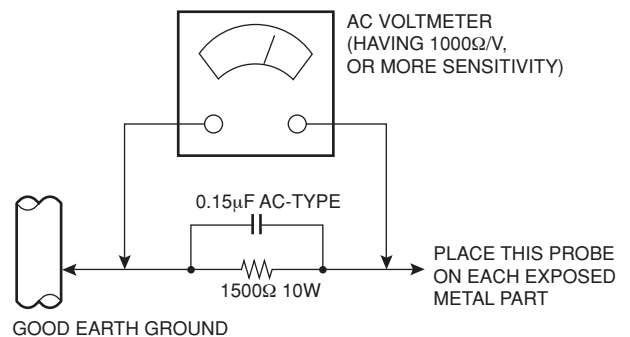

FEATURES

- New chassis design enables use of an interactive on-screen control.
- Pure flat CRT produces fine textured picture in every detail.
- Wide range voltage (110V ~ 240V) for AC power input.
- With AUDIO/VIDEO/COMPONENT input terminals.
- I² C bus control utilizes single chip ICs.
- By means of AUTO PROGRAM, the TV stations can be selected automatically and the TV channels can also be rearranged automatically.
- Built-in DIGITAL ECO MODE (ECONOMY, ECOLOGY).
 In accordance with the brightness in a room, the brightness and/or contrast of the picture can be adjusted automatically to make the optimum picture which is easy on the eye.
- Built-in OFF TIMER & RETURN +.

MAIN DIFFERENCE LIST

△	MODEL No.				
	Part Name	AV-21WH3	AV-21WS3/AU	AV-21WX3/A	AV-2178TEE
△	MAIN PWB ASS'Y	SCH-1099A-H2	SCH-1094A-H2	SCH-1077A-H2	SCH-1110A-H2
	FRONT CABINET ASS'Y	GG10198-003A-H	GG10198-001A-H	GG10198-002A-H	GG10198-010A-H
	REMOTE CONTROL UNIT	RM-C1011-1H	RM-C1010-1H	RM-C1014-1H	RM-C1013-1H

FUNCTIONS

FRONT PANEL

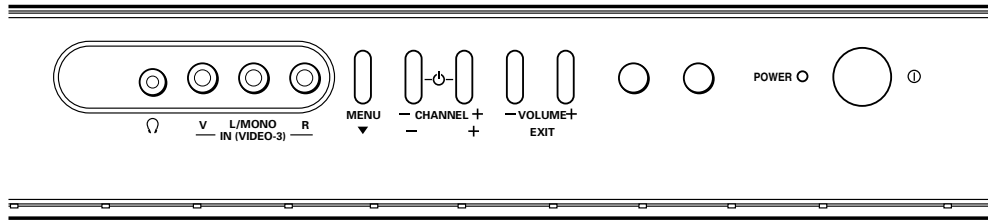

REAR PANEL

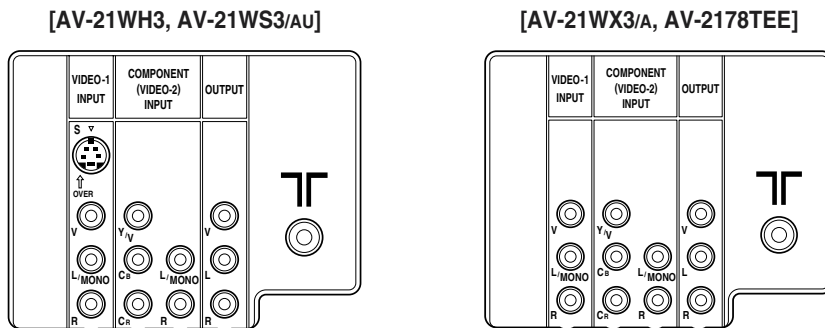

REMOTE CONTROL UNIT

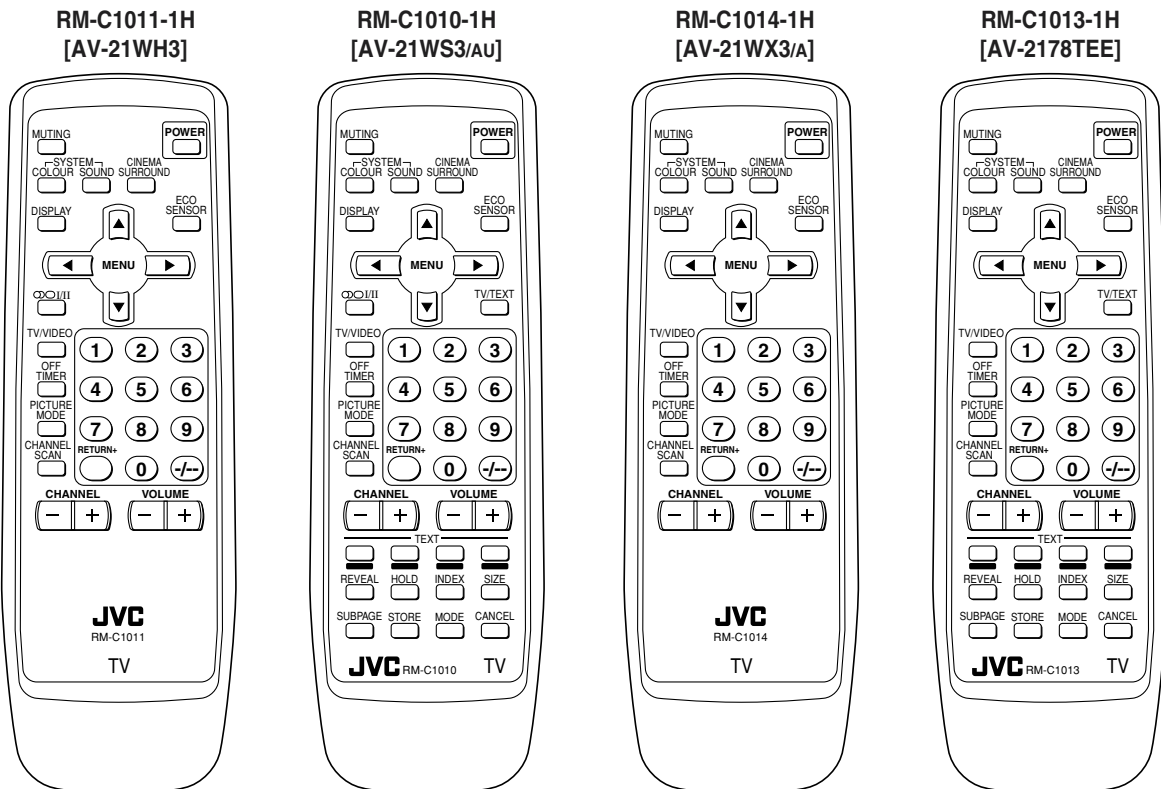

SPECIFIC SERVICE INSTRUCTIONS

DISASSEMBLY PROCEDURE

REMOVING THE REAR COVER

1. Unplug the power supply cord.
2. Remove the 9 screws marked (A) and 4 screws marked (B) as shown in Fig.1.
3. Withdraw the Rear cover toward you.

[CAUTION]

- When reinstalling the rear cover, carefully push it inward after inserting the Main PWB into the rear cover groove.

REMOVING THE MAIN PW BOARD

- After removing the rear cover.
1. Slightly raise the both sides of the Main PWB by hand.
 2. Withdraw the Main PWB backward.
(If necessary, take off the wire clamp and connectors, etc.)

REMOVING THE SPEAKER

- After removing the rear cover.
1. Remove the 2 screws marked (C) as shown in Fig.1.
 2. Follow the same steps when removing the other hand speaker.

CHECKING THE MAIN PW BOARD

1. To check the back side of the Main PWB.
 - 1) Pull out the Main PWB. (Refer to REMOVING THE MAIN PW BOARD).
 - 2) Erect the Main PWB vertically so that you can easily check its back side.

[CAUTION]

- Before turning on power, make sure that the CRT earth wire and other connectors are properly connected.
- When repairing, connect the Deg. coil to the DEG. connector on the Main PWB.

WIRE CLAMPING AND CABLE TYING

1. Be sure to clamp the wire.
2. Never remove the cable tie used for tying the wires together.
Should it be inadvertently removed, be sure to tie the wires with a new cable tie.

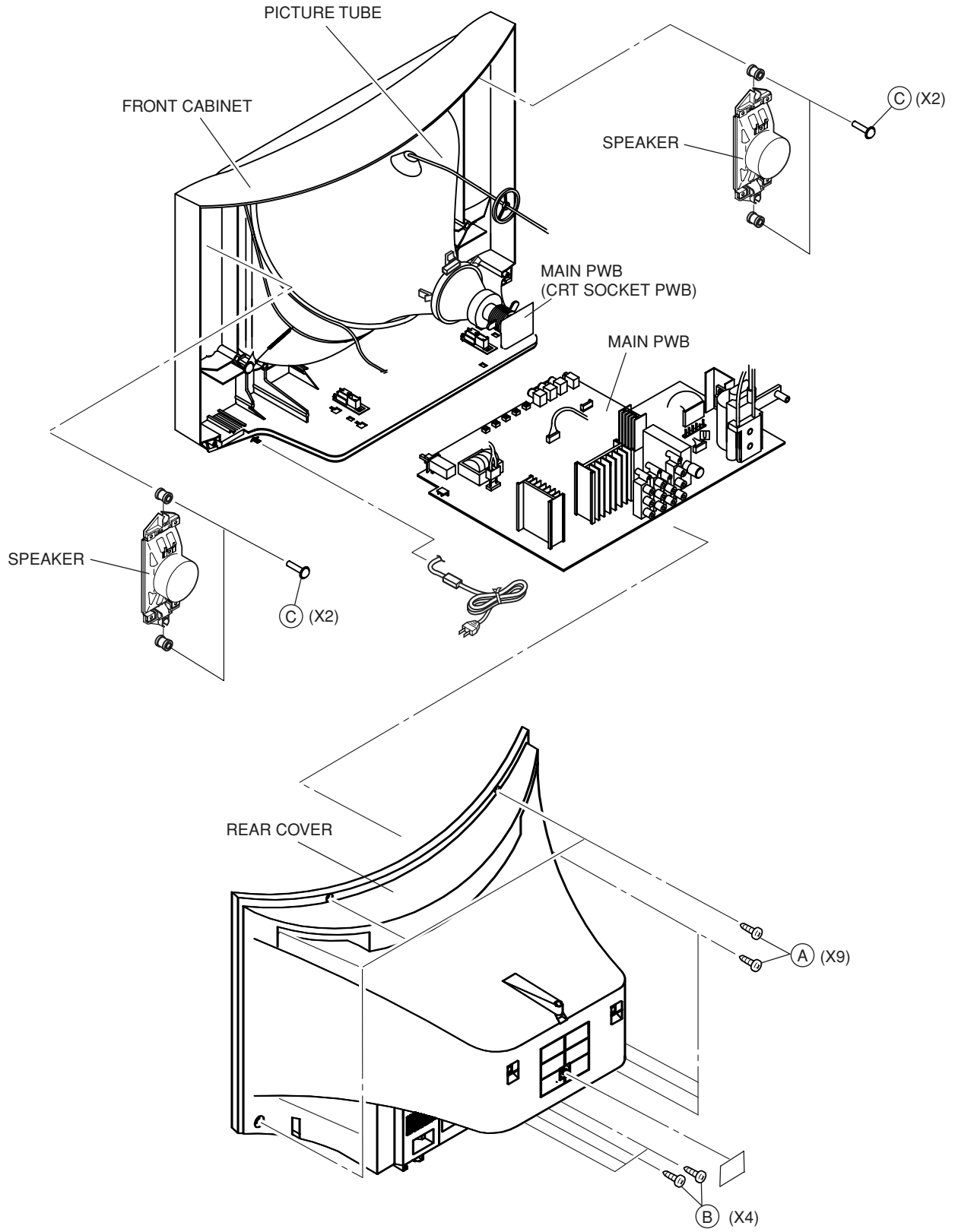

Fig.1

REMOVING THE CRT

* Replacement of the CRT should be performed by 2 or more persons.

- After removing the rear cover, chassis etc.,
- 1. Putting the CRT change table on soft cloth, the CRT change table should also be covered with such soft cloth (shown in Fig. 2).
- 2. While keeping the surface of CRT down, mount the TV set on the CRT change table balanced will as shown in Fig. 3.
- 3. Remove 4 screws marked by arrows with a box type screwdriver as shown in Fig. 3.
- Since the cabinet will drop when screws have been removed, be sure to support the cabinet with hands.
- 4. After 4 screws have been removed, put the cabinet slowly on cloth (At this time, be carefully so as not to damage the front surface of the cabinet) shown in Fig. 4.
- The CRT should be assembled according to the opposite sequence of its dismantling steps.

* The CRT change table should preferably be smaller than the CRT surface, and its height be about 35cm.

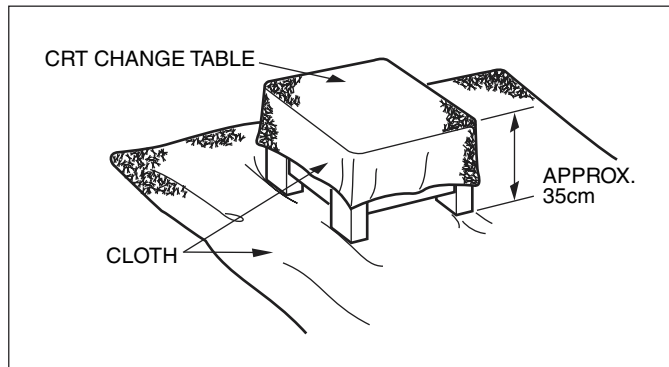

Fig. 2

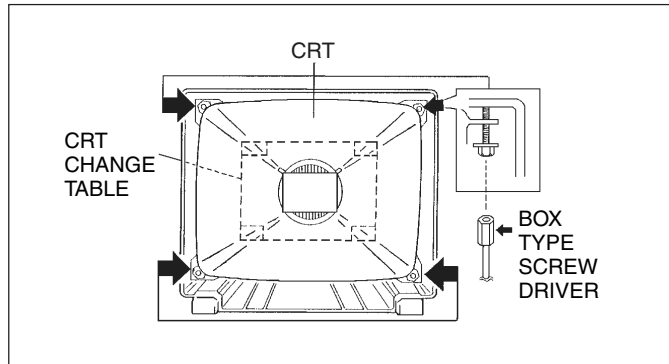

Fig. 3

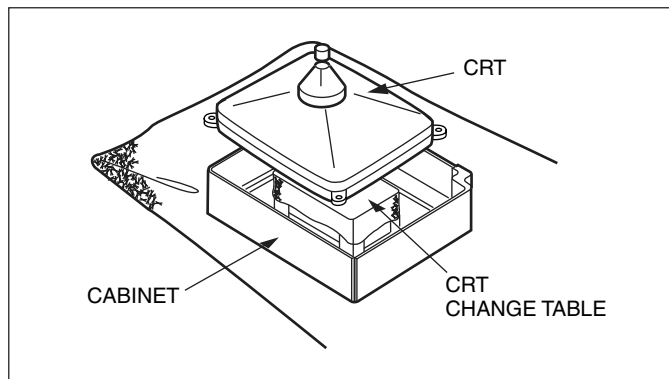

Fig. 4

COATING OF SILICON GREASE FOR ELECTRICAL INSULATION ON THE CRT ANODE CAP SECTION.

- Subsequent to replacement of the CRT and HV transformer or repair of the anode cap, etc. by dismantling them, be sure to coat silicon grease for electrical insulation as shown in Fig. 5.
- 1. Wipe around the anode button with clean and dry cloth. (Fig. 5)
- 2. Coat silicon grease on the section around the anode button. At this time, take care so that any silicon greases does not sticks to the anode button. (Fig. 6)

★ Silicon grease product No. KS - 650N

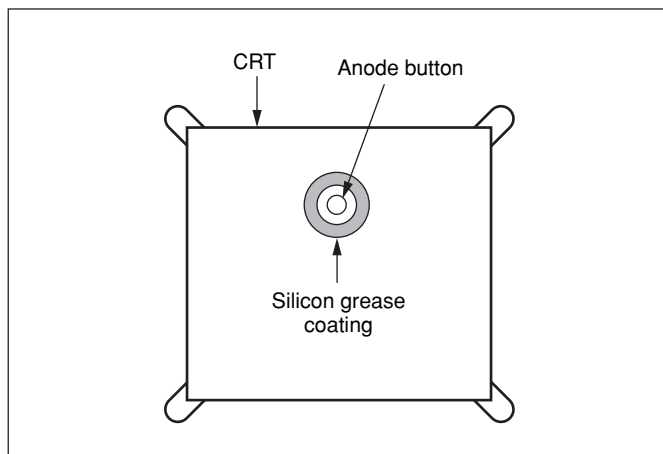

Fig. 5

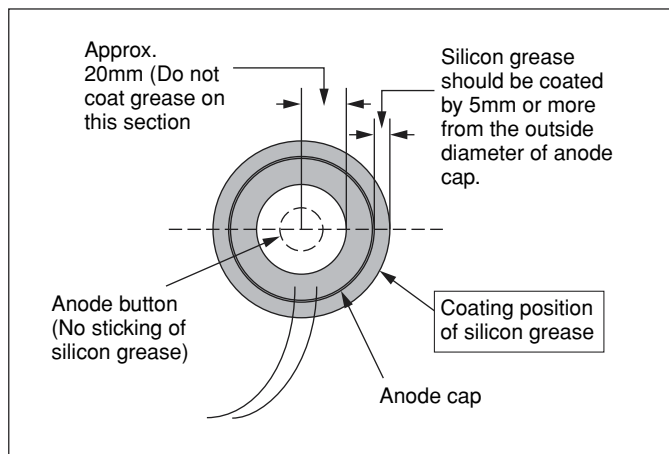

Fig. 6

REPLACEMENT OF MEMORY IC

1. MEMORY IC

This TV uses the following memory IC.

Memory IC: IC1702 on MAIN PW Board

The memory IC memorizes data for correctly operating the video and deflection circuits. When replacing the memory IC, be sure to use the same type IC written with the initial values of data. In other words, use the specific IC listed in "PRINTED WIRING BOARD PARTS LIST". For its mounting location, refer to "ADJUSTMENT LOCATIONS".

2. PROCEDURE FOR REPLACING MEMORY IC

(1) Power off

Switch the power off and unplug the power cord from the wall outlet.

(2) Replacing the memory IC

Replace the memory IC with new one. Be sure to use the memory IC written with the initial data values.

(3) Power on

Plug the power cord into the wall outlet and switch the power on.

(4) Check and setting of SYSTEM CONSTANT SET:

- 1) Press the DISPLAY key and the PICTURE MODE key on the remote control unit simultaneously.
The SERVICE MENU screen will be displayed.(See Fig.1.)
- 2) In the SERVICE MENU, press the DISPLAY key and PICTURE MODE key simultaneously. Then, the SYSTEM CONSTANT SET screen will be displayed.(See Fig.2.)
- 3) Check whether the setting values of the SYSTEM CONSTANT SET are the same as those indicated in Table1.
If the value is different, select the setting item with the MENU ∇/Δ key, and set the correct value with the MENU $\triangleleft/\triangleright$ key.
- 4) Press the DISPLAY key twice to return to the normal screen.

(5) Receive channel setting

Refer to the **OPERATING INSTRUCTIONS** and set the receive channels (channels preset).

(6) User setting

Check the user setting values in Table 2, and if setting value is different, set the correct value.
For setting, refer to the **OPERATING INSTRUCTIONS**.

(7) Setting of SERVICE MENU

Verify the setting for each setting item in the SERVICE MENU.(See Table 3.) If readjustment is necessary, perform adjustment referring to "SERVICE ADJUSTMENTS".

NAME OF REMOTE CONTROL KEYS

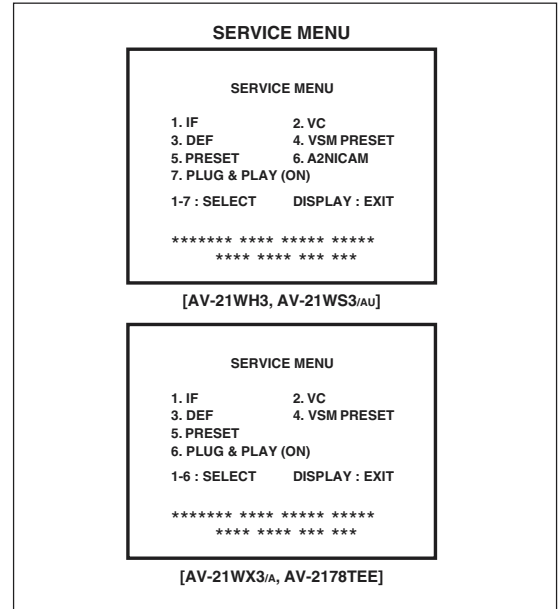
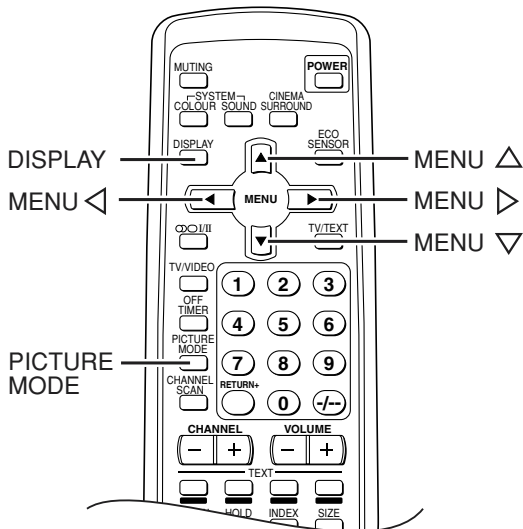

Fig. 1

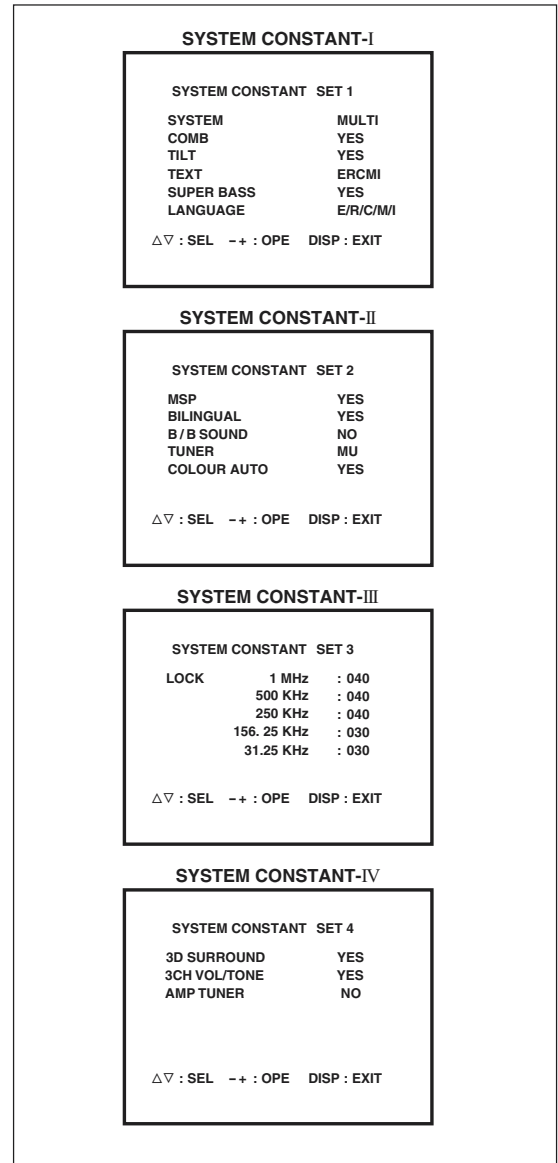

Fig. 2

SETTING OF SYSTEM CONSTANT SET

Setting item	Setting content	Setting value			
		AV-21WH3	AV-21WS3/AU	AV-21WX3/A	AV-2178TEE
SYSTEM	→ MULTI → TRIPLE → PAL → SINGLE → VIET ←	MULTI	←	←	←
COMB	→ YES → NO ←	NO	←	←	←
TILT	→ YES → NO ←	NO	←	←	←
TEXT	→ ERCMI → ERAPU → NO ←	NO	E/R/C/M/I	NO	E/R/A/P/U
SUPER BASS	→ YES → NO ←	NO	←	←	←
LANGUAGE	→ E/R/C/M/I → E/R/C → E/C ←	E/C	E/R/C/M/I	-	-
	→ E/R/A/P/U → E/R/A/P → E/R/U ←	-	-	E/R/A/P	E/R/A/P/U
MSP	→ YES → NO ←	YES	←	NO	←
BILINGUAL	→ YES → NO ←	NO	←	←	←
B/B SOUND	→ YES → NO ←	NO	←	YES	NO
TUNER	→ MU → MA ←	MU	←	←	←
COLOUR AUTO	→ YES → NO ←	NO	←	YES	NO
LOCK 1MHz	→ 000 → 240 ←	040	←	←	←
500KHz	→ 000 → 240 ←	040	←	←	←
250KHz	→ 000 → 240 ←	040	←	←	←
156.25KHz	→ 000 → 240 ←	030	←	←	←
31.25KHz	→ 000 → 240 ←	030	←	←	←
3D SURROUND	→ YES → NO ←	YES	←	←	←
3CH VOL/TONE	→ YES → NO ←	NO	←	←	←
AMP TUNER	→ YES → NO ←	NO	←	←	←

Table 1

USER SETTING VALUES

Setting item	Setting value
SUB POWER	ON
CHANNEL POSITION	1 POSITION
CHANNEL PRESET	REFER TO OPERATING INSTRUCTIONS
VOLUME	15 ± 2
TV/VIDEO	TV
VNR	OFF
COMPRESS (16:9)	OFF
AUTO SHUTOFF	OFF
CHILD LOCK	OFF
BLUE BACK	ON
VIDEO-2 SET	VIDEO
LANGUAGE	ENG
3D SURROUND	OFF
AI VOLUME	ON
ON SCREEN DISPLAY	POSITION INDICATION
COLOUR SYSTEM	PAL
SOUND SYSTEM	B/G
STEREO MODE	STEREO [AV-21WH3, AV-21WS3/AU only]
PICTURE MODE-VSM	BRIGHT
OFF TIMER	00
ECO SENSOR	OFF
BASS	CENTRE
TREBLE	CENTRE
BALANCE	CENTRE

Table 2

SERVICE MENU SETTING ITEMS

Service menu	Setting item	Service menu	Setting item
1. IF	1. VCO 2. DELAY POINT	5. PRESET Do not adjust	1. PSNS 2. ACL 3. MUS 4. MAT 5. FCO 6. BPS 7. IFLH 8. VID 9. STM 10. AFCW 11. VSW 12. FFI 13. AGC 14. CL 15. AKB 16. HBL 17. BKS 18. READ STATUS 19. VNR 20. PEAK 21. IVG 22. WPL 23. SOFT CLIPPER 24. IF PLL OFFSET 25. OVERSHOOT 26. HCO 27. HP2 28. AI VOLUME ADN 29. SUB BASS 3D 30. SUB TREBLE 3D 31. CCCLOOP
2. VC	1. CUTOFF(R/G) 2. DRIVE(R/G/B) 3. BRIGHT 4. CONT 5. COLOUR 6. TINT 7. SHARP 8. YDELAY 9. AMP T.SHARP		Do not adjust
3. DEF	1. VER. SLOPE 2. VER. HEIGHT 3. VER. POSITION 4. VER. SCURVE 5. HOR. POSITION 6. HOR. WIDTH 7. EW-PIN 8. EW-TRAPEZ 9. UP CORNER 10. DW CORNER 11. HOR. PARALL 12. HOR. BOW 13. V. ZOOM		
4. VSM PRESET (BRIGHT/STD/SOFT) Do not adjust	1. TINT 2. COLOUR 3. BRIGHT 4. CONT 5. SHARP		
		6. A2NICAM [AV-21WH3, AV-21WS3/AU only] Do not adjust	1. ERROR LIMIT 2. A2 ID THR 3. SOUND SYSTEM
		6/7. PLUG & PLAY(ON) Do not adjust	

Table 3

REPLACEMENT OF CHIP COMPONENT

■ CAUTIONS

1. Avoid heating for more than 3 seconds.
2. Do not rub the electrodes and the resist parts of the pattern.
3. When removing a chip part, melt the solder adequately.
4. Do not reuse a chip part after removing it.

■ SOLDERING IRON

1. Use a high insulation soldering iron with a thin pointed end of it.
2. A 30w soldering iron is recommended for easily removing parts.

■ REPLACEMENT STEPS

1. How to remove Chip parts

◆ Resistors, capacitors, etc.

- (1) As shown in the figure, push the part with tweezers and alternately melt the solder at each end.

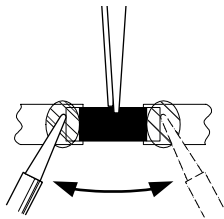

- (2) Shift with tweezers and remove the chip part.

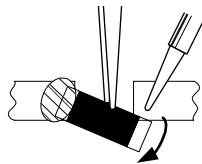

◆ Transistors, diodes, variable resistors, etc.

- (1) Apply extra solder to each lead.

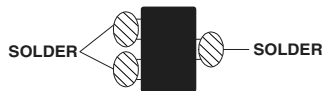

- (2) As shown in the figure, push the part with tweezers and alternately melt the solder at each lead. Shift and remove the chip part.

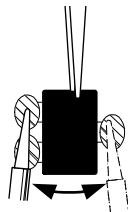

Note : After removing the part, remove remaining solder from the pattern.

2. How to install Chip parts

◆ Resistors, capacitors, etc.

- (1) Apply solder to the pattern as indicated in the figure.

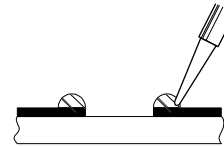

- (2) Grasp the chip part with tweezers and place it on the solder. Then heat and melt the solder at both ends of the chip part.

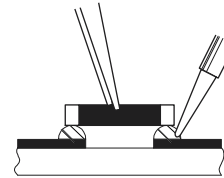

◆ Transistors, diodes, variable resistors, etc.

- (1) Apply solder to the pattern as indicated in the figure.
- (2) Grasp the chip part with tweezers and place it on the solder.
- (3) First solder lead **A** as indicated in the figure.

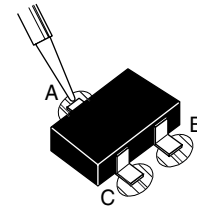

- (4) Then solder leads **B** and **C**.

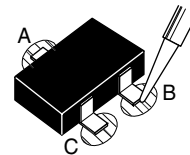

SERVICE ADJUSTMENTS

ADJUSTMENT PREPARATION

1. You can make the necessary adjustments for this unit with either the remote control unit or with the adjustment equipment and parts as given below.
2. Adjustment with the remote control unit is made on the basis of the initial setting values, however, the new setting values which set the screen to its optimum condition may differ from the initial settings.
3. Make sure that AC power is turned on correctly.
4. Turn on the power for the set and test equipment before use, and start the adjustment procedures after waiting at least 30 minutes.
5. Unless otherwise specified, prepare the most suitable reception or input signal for adjustment.
6. Never touch any adjustment parts, which are not specified in the list for this adjustment-variable resistors, transformers, capacitors, etc.
7. Presetting before adjustment.

Unless otherwise specified in the adjustment instructions, preset the following functions with the remote control unit.

- User mode setting position

Setting item	Setting value
PICTURE MODE(VSM)	BRIGHT
VNR	OFF
BASS, TREBLE, BALANCE	CENTRE
TINT, COLOUR, BRIGHT, SHARP	CENTRE
CONT	MAXIMUM

MEASURING INSTRUMENT

1. DC voltmeter (or Digital voltmeter)
2. Oscilloscope
3. Signal generator (Pattern generator) [PAL/SECAM/NTSC]
4. Remote control unit

ADJUSTMENT ITEMS

- B1 POWER SUPPLY
- FOCUS ADJUSTMENT
- IF CIRCUIT ADJUSTMENTS
 - Adjustment of VCO (CW)
 - Adjustment of DELAY POINT (AGC TAKE-OVER)
- VC (VIDEO/CHROMA) CIRCUIT ADJUSTMENTS
 - Adjustment of WHITE BALANCE (Low light)
 - Adjustment of WHITE BALANCE (High light)
 - Adjustment of SUB BRIGHT
 - Adjustment of SUB CONTRAST
 - Adjustment of SUB COLOUR-I
 - Adjustment of SUB COLOUR-II
 - Adjustment of SUB TINT-I
 - Adjustment of SUB TINT-II
- DEFLECTION CIRCUIT ADJUSTMENTS
 - Adjustment of V. SLOPE
 - Adjustment of V. POSITION
 - Adjustment of V. HEIGHT
 - Adjustment of H. POSITION
 - Adjustment of H. WIDTH
 - Adjustment of SIDE PIN
 - Adjustment of TRAPEZIUM
 - Adjustment of V. S-CURVE
 - Adjustment of CORNER
 - Adjustment of H. PARALLEL
 - Adjustment of H. BOW
- VSM PRESET SETTING
- PRESET SETTING
- AUDIO ADJUSTMENT [AV-21WH3, AV-21WS3/AU only]
- PURITY ADJUSTMENT
- CONVERGENCE ADJUSTMENTS
 - Adjustment of STATIC CONVERGENCE
 - Adjustment of DYNAMIC CONVERGENCE

ADJUSTMENT LOCATIONS

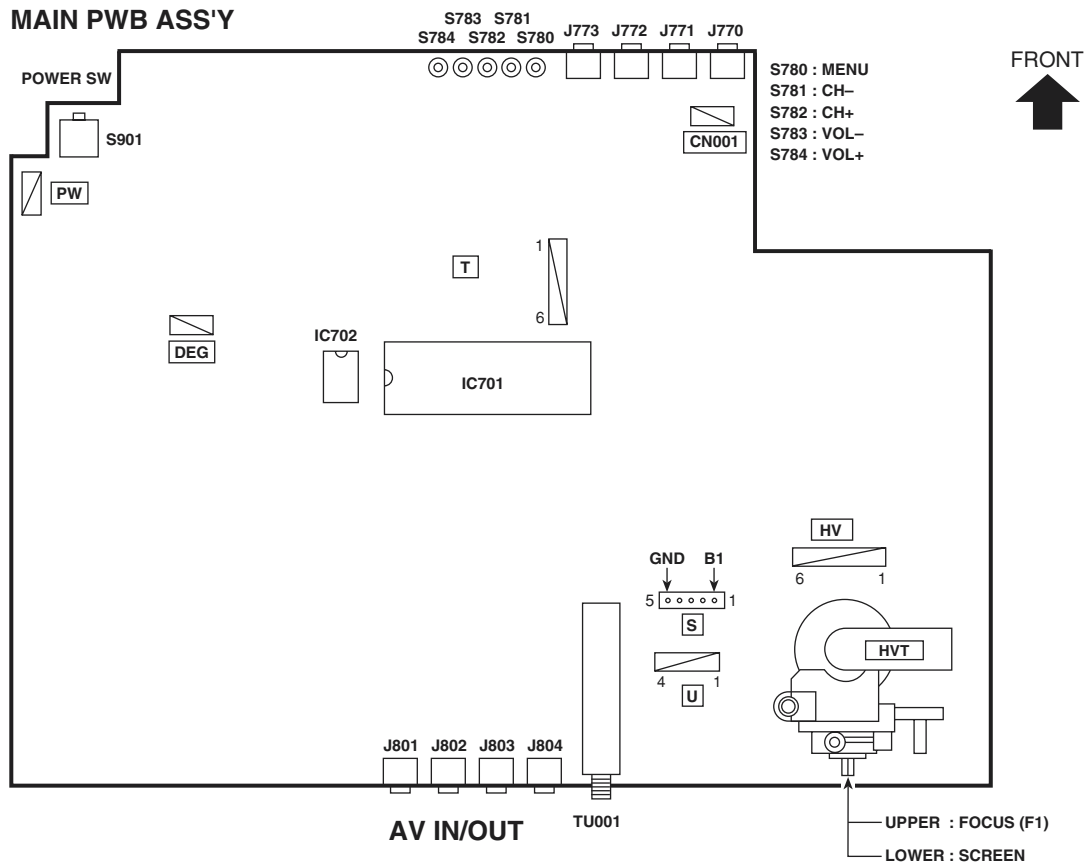

MAIN PWB ASS'Y (CRT SOCKET)

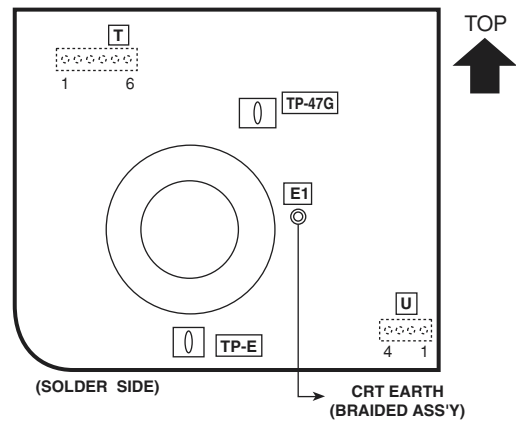

BASIC OPERATION IN SERVICE MENU

1. TOOL OF SERVICE MENU OPERATION

Operate the SERVICE MENU with the remote control unit.

2. SERVICE MENU ITEMS

With the SERVICE MENU, various settings (adjustments) can be made, and they are broadly classified in the following items of settings:

- 1. IF For entering/adjusting the setting values (adjustment values) of the IF circuit.
- 2. VC For entering/adjusting the setting values (adjustment values) of the VIDEO/CHROMA circuit.
- 3. DEF For entering/adjusting the setting values (adjustment values) of the DEFLECTION circuit.
- 4. VSM PRESET For setting the values of STANDARD, SOFT and BRIGHT.
(VSM: video status memory)
- 5. PRESET For setting the values of the preset.
- 6. A2NICAM For entering/adjusting the setting values (adjustment values) of the multiplicity sound circuit.
[AV-21WH3, AV-21WS3/AU only]
- 6/7. PLUG & PLAY (ON) This is not used for service.

3. BASIC OPERATION IN SERVICE MENU

(1) How to enter SERVICE MENU

Press the DISPLAY key and the PICTURE MODE key on the remote control unit simultaneously.
The SERVICE MENU screen will be displayed. (See Fig. 1 on the next page.)

(2) Selection of SUB MENU SCREEN

Press one of the keys 1 to 7 on the remote control unit, and select the SUB MENU SCREEN from the SERVICE MENU. (See Fig. 1 on the next page.)

SERVICE MENU → SUB MENU	1. IF
	2. VC
	3. DEF
	4. VSM PRESET
	5. PRESET
	6. A2NICAM [AV-21WH3, AV-21WS3/AU only]
	6/7. PLUG & PLAY (ON)

(3) Method of Setting

- *Once the setting values are set, they are memorized automatically.
- *It must not adjust without inputting a signal.

1) 1. IF

[1.VCO]

- (a) 1 Key Select **1. IF**.
- (b) 1 Key Select **1. VCO**.
- (c) DISPLAY Key When this is pressed twice, you will return to the SERVICE MENU.
 - Under normal conditions, no adjustment is required.

[2.DELAY POINT]

- (a) 1 Key Select **1. IF**.
- (b) 2 Key Select **2. DELAY POINT**.
- (c) MENU </> Key Adjust the setting value.
- (d) DISPLAY Key When this is pressed twice, you will return to the SERVICE MENU.

2) 2. VC, 3. DEF, 4. VSM PRESET, 5. PRESET and 6. A2NICAM

- (a) 2 ~6 Keys Select one from **2. VC**, **3. DEF**, **4. VSM PRESET**, **5. PRESET** and **6. A2NICAM**.
- (b) MENU ∇/△ key Select setting items.
- (c) MENU </> Key Adjust the setting values of the setting items.
 - Use the number keys on the remote control unit for setting of WHITE BALANCE.
For the setting, refer to each item concerned.
- (d) DISPLAY Key When this is pressed, you will return to the SERVICE MENU.

3) 6/7. PLUG & PLAY (ON)

This is not used for service.

(4) Release of SERVICE MENU

After completing the setting, return to the SERVICE MENU by pressing the DISPLAY key, then again press the DISPLAY key to return to the normal screen.

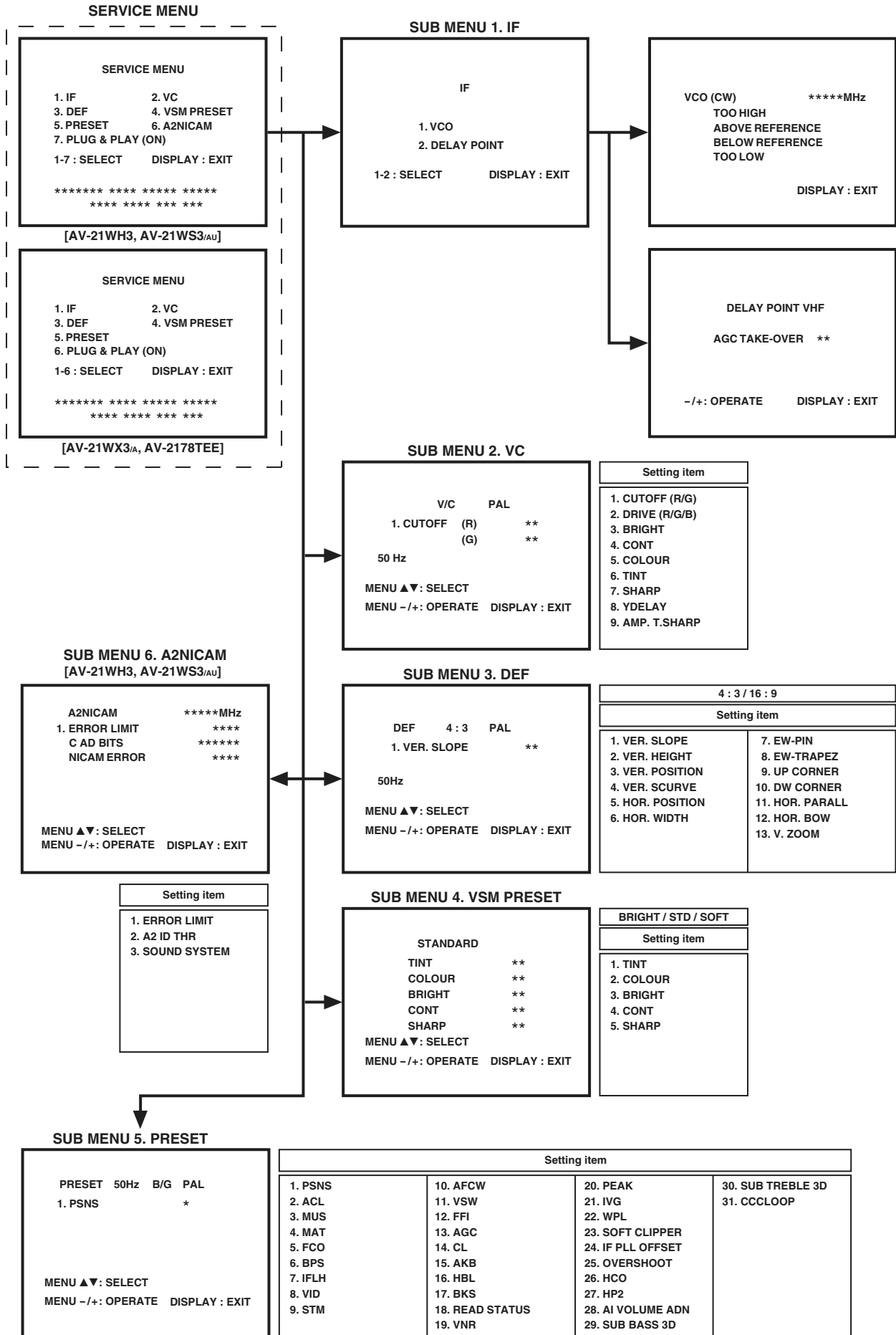

Fig. 1

ADJUSTMENTS

B1 POWER SUPPLY

Item	Measuring instrument	Test point	Adjustment part	Description
Check of B1 POWER SUPPLY	Signal Generator DC Voltmeter	B1 (pin 1) GND (pin 5) [CN00S connector in MAIN PWB]		<ol style="list-style-type: none"> 1. Receive a black and white signal. 2. Connect a DC voltmeter between B1 and GND (between pin 1 and 5 of the connector CN00S). 3. Make sure that the voltage is DC135 ± 2V.

FOCUS ADJUSTMENT

Item	Measuring instrument	Test point	Adjustment part	Description
Adjustment of FOCUS	Signal generator		FOCUS VR [In HVT]	<p>Notes:</p> <ul style="list-style-type: none"> • Set PICTURE MODE (VSM) to "BRIGHT". • The final adjustment of CONVERGENCE must be done after the FOCUS adjustment. (CONVERGENCE is changed by FOCUS adjustment.) <p>When makes difference by FOCUS adjustment, should be reconfirming PURITY adjustment.</p> <ol style="list-style-type: none"> 1. Receive a cross-hatch signal. 2. While looking at the screen centre, adjust the FOCUS VR so that the vertical and horizontal lines will be clear and in fine detail. 3. Make sure that the picture is in focus even when the screen gets darkened.

IF CIRCUIT ADJUSTMENTS

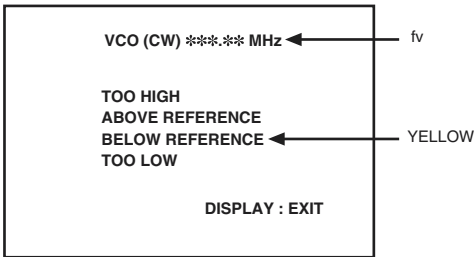
Item	Measuring instrument	Test point	Adjustment part	Description				
Adjustment of VCO (CW)	Remote control unit		VCO (CW)	<p>Note:</p> <ul style="list-style-type: none"> • Under normal conditions, no adjustment is required. <ol style="list-style-type: none"> 1. Select 1. IF from the SERVICE MENU. 2. Select 1. VCO by pressing the 1 key on the remote control unit. 3. Receive a broadcast signal. 4. Check the characters colour of the BELOW REFERENCE displayed to yellow. 5. Press the DISPLAY key three times to return to normal screen. 				
 <p>The screenshot shows a menu with the following text: "VCO (CW) ***.*** MHz" with an arrow pointing to "fv". Below it, "TOO HIGH ABOVE REFERENCE" and "BELOW REFERENCE TOO LOW" with an arrow pointing to "YELLOW". At the bottom, it says "DISPLAY : EXIT".</p>								
Adjustment of DELAY POINT (AGC TAKE-OVER)	Remote control unit		DELAY POINT	<ol style="list-style-type: none"> 1. Receive a black and white broadcast signal (colour off). 2. Select 1. IF from the SERVICE MENU. 3. Select 2. DELAY POINT by pressing the 2 key on the remote control unit. 4. Adjust the MENU </> key in order to eliminate any noise or beat from the image. Any increase above the initial value produces noise and any decrease below it produces beat. 5. Press the DISPLAY key three times to return to the normal screen. 6. Turn to other channels and make sure that there are no irregularities. 				
<table border="1" style="margin-left: auto; margin-right: auto;"> <thead> <tr> <th>Setting (Adjustment time)</th> <th>Initial setting value</th> </tr> </thead> <tbody> <tr> <td>DELAY POINT (AGC TAKE-OVER)</td> <td style="text-align: center;">26</td> </tr> </tbody> </table>					Setting (Adjustment time)	Initial setting value	DELAY POINT (AGC TAKE-OVER)	26
Setting (Adjustment time)	Initial setting value							
DELAY POINT (AGC TAKE-OVER)	26							

VC (VIDEO/CHROMA) CIRCUIT ADJUSTMENTS

The setting (adjustment) using the remote control unit is made on the basis of the initial setting values.
The setting values which adjust the screen to the optimum condition can be different from the initial setting values.
● Do not change the initial setting values of the setting (adjustment) items not listed in "ADJUSTMENT".

[SUB MENU 2. VC] : Do not adjust.

	Setting (Adjustment) item	Variable range	Initial setting value				
			PAL	SECAM	NTSC3.58	NTSC 4.43	COMPONENT
1	CUT-OFF (R/G)	-32 ~ +31	0	←	←	←	←
2	DRIVE (R/G/B)	-32 ~ +31	0	←	←	←	←
3	BRIGHT (COM./TV/V-1/V-2/V-3)	-32 ~ +31	0/-18/0/0/0	←	←	←	←
4	CONT	-32 ~ +31	-20	←	←	←	—
5	COLOUR	-32 ~ +31	-5	-3	-12	-2	-3
6	TINT (TV/VIDEO)	-32 ~ +31	—	—	-15/-4	+1/+1	—
7	SHARP (TV/VIDEO)	-32 ~ +31	-10/0	←	←	←	—/0
8	Y DELAY (TV/VIDEO/S) *1	-8 ~ +7	0/+1/0	+5/+1/+1	0/+1/+1	+5/0/+1	—
	Y DELAY (TV/VIDEO) *2		0/+1	+5/+1	0/+1	+5/0	—
9	AMP T. SHARP	-32 ~ +31	0	←	←	←	←

*1: AV-21WH3, AV-21WS3/AU

*2: AV-21WX3/A, AV-2178TEE

Item	Measuring instrument	Test point	Adjustment part	Description
Adjustment of WHITE BALANCE (Low light)	Signal generator		1. CUTOFF (R) CUTOFF (G)	<p>Note:</p> <ul style="list-style-type: none"> Set PICTURE MODE (VSM) to "BRIGHT". <ol style="list-style-type: none"> Receive a PAL black and white signal (colour off). Select 2. VC from the SERVICE MENU. Select 1. CUTOFF (R) and (G) with MENU ∇/Δ key, and set each value to initial setting value with the 4 and 7 key, or 5 and 8 key on the remote control unit. Press the 1 key on the remote control unit to produce a single horizontal line. Turn the SCREEN VR fully counterclockwise, then slowly turn it clockwise to where a red, blue or green colour is faintly visible. Use the keys 4 and 7 or 5 and 8 on the remote control unit and adjust the other 2 colours to where the single horizontal line appears white. Turn the SCREEN VR to where the single horizontal line glows faintly. Press the 2 key to return to 1. CUTOFF screen. Press the DISPLAY key twice to return to the normal screen.
	Remote control unit		SCREEN VR [In HVT]	

V/C PAL

1. CUTOFF (R) **

 (G) **

50 Hz

MENU \blacktriangle \blacktriangledown : SELECT

MENU -/+ : OPERATE DISPLAY : EXIT

REMOTE CONTROL UNIT

Setting (Adjustment) Item	Variable range	Initial setting value
1. CUT OFF	R	-32 ~ +31
	G	-32 ~ +31

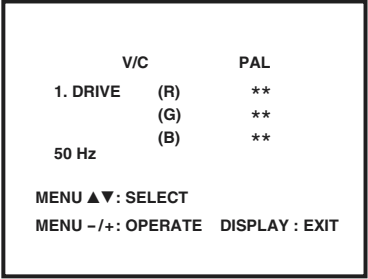
Item	Measuring instrument	Test point	Adjustment part	Description													
Adjustment of WHITE BALANCE (High light)	Signal generator Remote control unit		2. DRIVE (R) DRIVE (G) DRIVE (B)	<p>Notes:</p> <ul style="list-style-type: none"> • Proceed to the following adjustment after having completed the adjustment of LOW LIGHT WHITE BALANCE. • Set PICTURE MODE (VSM) to "BRIGHT". <ol style="list-style-type: none"> 1. Receive a PAL black and white signal (colour off). 2. Select 2. VC from the SERVICE MENU. 3. Select 2. DRIVE (R), (G) and (B) with MENU ∇/Δ key, and set each value to initial setting value with the 4 to 9 keys on the remote control unit. 4. Use the keys 4 to 9 to produce a white screen. 5. Press the DISPLAY key twice to return to the normal screen. <table border="1" data-bbox="808 611 1419 779"> <thead> <tr> <th>Setting (Adjustment) Item</th> <th>Variable range</th> <th>Initial setting value</th> </tr> </thead> <tbody> <tr> <td rowspan="3">2. DRIVE</td> <td>R</td> <td>-32 — +31</td> <td>0</td> </tr> <tr> <td>G</td> <td>-32 — +31</td> <td>0</td> </tr> <tr> <td>B</td> <td>-32 — +31</td> <td>0</td> </tr> </tbody> </table>	Setting (Adjustment) Item	Variable range	Initial setting value	2. DRIVE	R	-32 — +31	0	G	-32 — +31	0	B	-32 — +31	0
Setting (Adjustment) Item	Variable range	Initial setting value															
2. DRIVE	R	-32 — +31	0														
	G	-32 — +31	0														
	B	-32 — +31	0														
Adjustment of SUB BRIGHT	Remote control unit		3. BRIGHT	<p>Notes:</p> <ul style="list-style-type: none"> • Proceed to the following adjustment after having completed the adjustments of LOW LIGHT WHITE BALANCE and HIGH LIGHT WHITE BALANCE. • Set PICTURE MODE (VSM) to "BRIGHT". <ol style="list-style-type: none"> 1. Receive a broadcast. 2. Select 2. VC from the SERVICE MENU. 3. Select 3. BRIGHT with the MENU ∇/Δ key. 4. Set the initial setting value with the MENU $\triangleleft/\triangleright$ key. 5. If the brightness is not best with the initial setting value, make fine adjustment until you get the best brightness. 6. Press the DISPLAY key twice to return to the normal screen. 													
Adjustment of SUB CONTRAST	Remote control unit		4. CONT	<p>Notes:</p> <ul style="list-style-type: none"> • Proceed to the following adjustment after having completed the adjustment of SUB BRIGHT. • Set PICTURE MODE (VSM) to "BRIGHT". <ol style="list-style-type: none"> 1. Receive a broadcast. 2. Select 2. VC from the SERVICE MENU. 3. Select 4. CONT with the MENU ∇/Δ key. 4. Set the initial setting value with the MENU $\triangleleft/\triangleright$ key. 5. If the contrast is not best with the initial setting value, make fine adjustment until you get the best contrast. 6. Press the DISPLAY key twice to return to the normal screen. 													

Item	Measuring instrument	Test point	Adjustment part	Description
Adjustment of SUB COLOUR-I	Remote control unit		5. COLOUR	<p>[Method of adjustment without measuring instrument]</p> <p>Notes:</p> <ul style="list-style-type: none"> • Proceed to the following adjustment after having completed the adjustment of SUB CONT. • Set PICTURE MODE (VSM) to "BRIGHT". <p>– PAL COLOUR –</p> <ol style="list-style-type: none"> 1. Receive a PAL broadcast. 2. Select 2. VC from the SERVICE MENU. 3. Select 5. COLOUR with the MENU ∇/Δ key. 4. Set the initial setting value for PAL COLOUR with the MENU \langle/\rangle key. 5. If the colour is not best with the initial setting value, make fine adjustment until you get the best colour. 6. Press the DISPLAY key twice to return to the normal screen. <p>– SECAM COLOUR –</p> <ol style="list-style-type: none"> 7. Receive a SECAM broadcast. 8. Press the COLOUR SYSTEM button on the remote control unit to select the SECAM colour system. 9. Make fine adjustment of SECAM COLOUR in the same way as for "PAL COLOUR". <p>– NTSC 3.58 COLOUR –</p> <ol style="list-style-type: none"> 10. Receive a NTSC 3.58MHz broadcast. 11. Press the COLOUR SYSTEM button on the remote control unit to select the NTSC 3.58 colour system. 12. Make similar fine adjustment of NTSC 3.58 COLOUR in the same way as for "PAL COLOUR". <p>– NTSC 4.43 COLOUR –</p> <p>When adjustment is done for NTSC 3.58 COLOUR, appropriate values are automatically set for NTSC 4.43 COLOUR.</p>
Adjustment of SUB COLOUR-II	Signal generator Oscilloscope Remote control unit	TP-47G TP-E (77) [MAIN PWB (CRT SOCKET)]	5. COLOUR	<p>[Method of adjustment using measuring instrument]</p> <p>Notes:</p> <ul style="list-style-type: none"> • Proceed to the following adjustment after having completed the adjustment of SUB CONT. • Set PICTURE MODE (VSM) to "BRIGHT". <p>– PAL COLOUR –</p> <ol style="list-style-type: none"> 1. Receive a PAL colour bar signal (full field colour bar 75% white). 2. Select 2. VC from the SERVICE MENU. 3. Select 5. COLOUR with the MENU ∇/Δ key. 4. Set the initial setting value of PAL COLOUR with the MENU \langle/\rangle key. 5. Connect the oscilloscope between TP-47G and TP-E. 6. Adjust PAL COLOUR to set the value (A) in the figure to +13V (V_{w-G}). <p>– SECAM COLOUR –</p> <ol style="list-style-type: none"> 7. Receive a SECAM colour bar signal (full field colour bar 75% white). 8. Press the COLOUR SYSTEM button on the remote control unit to select the SECAM colour system. 9. Set the initial setting value of SECAM COLOUR with the MENU \langle/\rangle key. 10. Adjust SECAM COLOUR to set the value (A) in the figure to +2V (V_{w-G}). <p>– NTSC 3.58 COLOUR –</p> <ol style="list-style-type: none"> 11. Receive a NTSC 3.58 colour bar signal (full field colour bar 75% white). 12. Press the COLOUR SYSTEM button on the remote control unit to select the NTSC 3.58 colour system. 13. Set the initial setting value of NTSC 3.58 COLOUR with the MENU \langle/\rangle key. 14. Adjust NTSC 3.58 COLOUR to set the value (A) in the figure to +3V (V_{w-G}). <p>– NTSC 4.43 COLOUR –</p> <p>When adjustment is done for NTSC 3.58 COLOUR, appropriate values are automatically set for NTSC 4.43 COLOUR.</p>

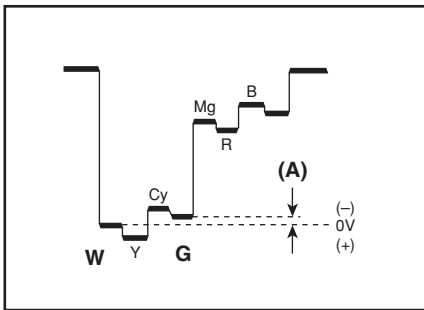

Item	Measuring instrument	Test point	Adjustment part	Description
Adjustment of SUB TINT-I	Signal generator Remote control unit		6. TINT	<p>[Method of adjustment without measuring instrument]</p> <p>Notes:</p> <ul style="list-style-type: none"> • Proceed to the following adjustment after having completed the adjustment of SUB CONT. • Set PICTURE MODE (VSM) to "BRIGHT". <p>– NTSC 3.58 TINT –</p> <ol style="list-style-type: none"> 1. Receive a NTSC 3.58 colour bar signal (full field colour bar 75% white). 2. Press the COLOUR SYSTEM button on the remote control unit to select the NTSC 3.58 colour system. 3. Select 2. VC from the SERVICE MENU. 4. Select 6. TINT with the MENU ∇/Δ key. 5. Set the initial setting value of NTSC 3.58 with the MENU $\triangleleft/\triangleright$ key. 6. If you cannot get the best tint with the initial setting value, make fine adjustment until you get the best tint. 7. Press the DISPLAY key twice to return to the normal screen. <p>– NTSC 4.43 TINT –</p> <p>When adjustment is done for NTSC 3.58 TINT, appropriate values are automatically set for NTSC 4.43 TINT.</p>
Adjustment of SUB TINT-II	Signal generator Oscilloscope Remote control unit	TP-47G TP-E (\nearrow) [MAIN PWB (CRT SOCKET)]	6. TINT	<p>[Method of adjustment using measuring instrument]</p> <p>Notes:</p> <ul style="list-style-type: none"> • Proceed to the following adjustment after having completed the adjustment of SUB CONT. • Set PICTURE MODE (VSM) to "BRIGHT". <p>– NTSC 3.58 TINT –</p> <ol style="list-style-type: none"> 1. Receive a NTSC 3.58 colour bar signal (full field colour bar 75% white). 2. Press the COLOUR SYSTEM button on the remote control unit to select the NTSC 3.58 colour system. 3. Select 2. VC from the SERVICE MENU. 4. Select 6. TINT with the MENU ∇/Δ key. 5. Set the initial setting value of NTSC 3.58 with the MENU $\triangleleft/\triangleright$ key. 6. Connect the oscilloscope between TP-47G and TP-E. 7. Adjust NTSC 3.58 TINT to set the value (B) in the figure to +0V (V_{w-cy}). 8. Press the DISPLAY key twice to return to the normal screen. <p>– NTSC 4.43 TINT –</p> <p>When adjustment is done for NTSC 3.58 TINT, appropriate values are automatically set for NTSC 4.43 TINT.</p>

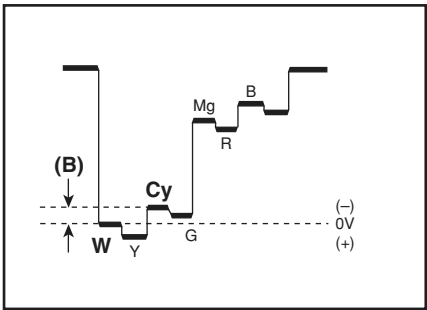

DEFLECTION CIRCUIT ADJUSTMENTS

The setting (adjustment) using the remote control unit is made on the basis of the initial setting values.
The setting values which adjust the screen to the optimum condition can be different from the initial setting values.

Note:

Proceed to the following adjustment after having completed the adjustments of SUB BRIGHT and SUB CONT.

[SUB MENU 3. DEF]

Setting (Adjustment) item	Variable range	Initial setting value				
		4:3		COMPRESS(16:9)		COMPONENT DVD (50Hz)
		50Hz	60Hz	50Hz	60Hz	
1. VER. SLOPE	-32 — +31	+2	-0	+2	-0	—
2. VER. HEIGHT	-32 — +31	+31	+31	-21	-20	—
3. VER. POSITION	-32 — +31	-12	-2	-12	-2	—
4. VER. SCURVE	-32 — +31	-8	+2	-8	+2	—
5. HOR. POSITION	-32 — +31	+2	+6	+2	+6	+7
6. HOR. WIDTH	-32 — +31	-0	-0	-0	-0	—
7. EW-PIN	-32 — +31	-0	-0	-0	-0	—
8. EW-TRAPEZ	-32 — +31	-0	-0	-0	-0	—
9. UP CORNER	-32 — +31	-0	-0	-0	-0	—
10. DW CORNER	-32 — +31	-0	-0	-0	-0	—
11. HOR. PARALL	-32 — +31	-0	-0	-0	-0	—
12. HOR. BOW	-32 — +31	-0	-0	-0	-0	—
13. V.ZOOM	-32 — +31	-0	-1	+10	+12	—

[COMPRESS (16:9) : OFF, fv: 50Hz mode]

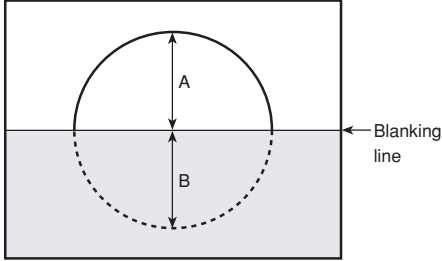
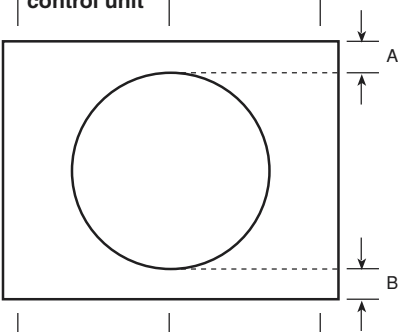
Item	Measuring instrument	Test point	Adjustment part	Description
Adjustment of V. SLOPE	Signal generator Remote control unit		1. VER. SLOPE	<ol style="list-style-type: none"> 1. Receive a PAL circle pattern signal of vertical frequency 50Hz. 2. Select 3. DEF from the SERVICE MENU. 3. Select 1. VER. SLOPE with the MENU ∇/Δ key. 4. Set the initial setting value of 1. VER. SLOPE with the MENU \langle/\rangle key. 5. Adjust 1. VER. SLOPE to make "A = B" with the MENU \langle/\rangle key.
				
Adjustment of V. POSITION	Signal generator Remote control unit		3. VER. POSITION	<ol style="list-style-type: none"> 6. Select 3. VER. POSITION with the MENU ∇/Δ key. 7. Set the initial setting value of 3. VER. POSITION with the MENU \langle/\rangle key. 8. Adjust 3. VER. POSITION to make "A = B" with the MENU \langle/\rangle key.
				
				(to be continued)

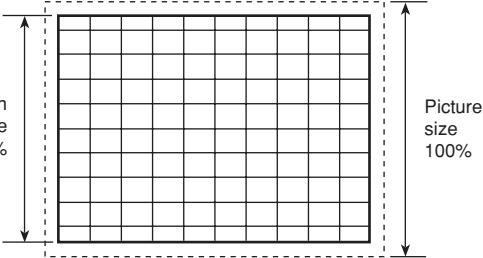
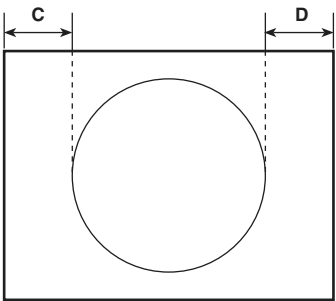
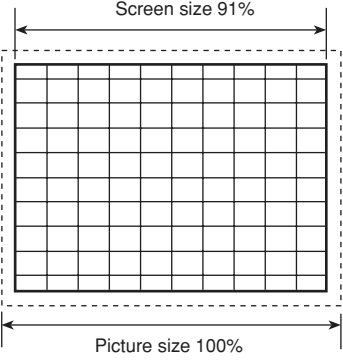
Item	Measuring instrument	Test point	Adjustment part	Description
Adjustment of V. HEIGHT	Signal generator Remote control unit		2. VER. HEIGHT 13. V. ZOOM	9. Receive a PAL cross-hatch signal. 10. Select 2. VER. HEIGHT with the MENU ∇/Δ key. 11. Set the initial setting value of 2. VER. HEIGHT with the MENU \langle/\rangle key. 12. Select 13. V. ZOOM with the MENU ∇/Δ key. 13. Set the initial setting value of 13. V. ZOOM with the MENU \langle/\rangle key. 14. Adjust 13. V. ZOOM and make the vertical screen size 91% of the picture size with the MENU \langle/\rangle key.
				
Adjustment of H. POSITION	Signal generator Remote control unit		5. HOR. POSITION	15. Receive a PAL circle pattern signal. 16. Select 5. HOR. POSITION with the MENU ∇/Δ key. 17. Set the initial setting value of 5. HOR. POSITION with the MENU \langle/\rangle key. 18. Adjust 5. HOR POSITION to make "C=D" with the MENU \langle/\rangle key.
				
Adjustment of H. WIDTH	Signal generator Remote control unit		6. HOR. WIDTH	19. Receive a PAL cross-hatch signal. 20. Select 6. HOR. WIDTH with the MENU ∇/Δ key. 21. Set the initial setting value of 6. HOR. WIDTH with the MENU \langle/\rangle key. 22. Adjust 6. HOR. WIDTH and make the horizontal screen size 91% of the picture size with the MENU \langle/\rangle key. (to be continued)
				

Item	Measuring instrument	Test point	Adjustment part	Description
Adjustment of SIDE PIN	Signal generator Remote control unit		7. EW-PIN	23. Select 7. EW-PIN with the MENU ∇/Δ key. 24. Set the initial setting value of 7. EW-PIN with the MENU \langle/ \rangle key. 25. Adjust 7. EW-PIN so that the first vertical lines at the left and right edges on the screen are straight.
Adjustment of TRAPEZIUM	Signal generator Remote control unit		8. EW-TRAPEZ	26. Select 8. EW-TRAPEZ with the MENU ∇/Δ key. 27. Set the initial setting value of 8. EW-TRAPEZ with the MENU \langle/ \rangle key. 28. Adjust 8. EW-TRAPEZ so that the vertical lines at the left and right edges on the screen are in parallel.
Adjustment of V.S-CURVE	Signal generator Remote control unit		4. VER. SCURVE	29. Select 4. VER. SCURVE with the MENU ∇/Δ key. 30. Set the initial setting value of 4. VER. SCURVE with the MENU \langle/ \rangle key. 31. Adjust 4. VER. SCURVE so that the spaces of each line on TOP, CENTRE and BOTTOM become uniform.
(to be continued)				

Item	Measuring instrument	Test point	Adjustment part	Description
Adjustment of CORNER	Signal generator Remote control unit		9. UP CORNER 10. DW CORNER	32. Select 9. UP CORNER with the MENU ∇/Δ key. 33. Set the initial setting value of 9. UP CORNER with the MENU \langle/\rangle key. 34. Select 10. DW CORNER with the MENU ∇/Δ key. 35. Set the initial setting value of 10. DW CORNER with the MENU \langle/\rangle key. 36. Adjust 9. UP CORNER and 10. DW CORNER so that the vertical lines at the four corners on the screen are straight.
Adjustment of H. PARALLEL	Signal generator Remote control unit		11. HOR. PARALL	37. Select 11. HOR. PARALL with the MENU ∇/Δ key. 38. Set the initial setting value of 11. HOR. PARALL with the MENU \langle/\rangle key. 39. Adjust 11. HOR. PARALL to optimize the parallelogram distortion.
Adjustment of H. BOW	Signal generator Remote control unit		12. HOR. BOW	40. Select 12. HOR. BOW with the MENU ∇/Δ key. 41. Set the initial setting value of Select 12. HOR. BOW with the MENU \langle/\rangle key. 42. Adjust 12. HOR. BOW to optimize the horizontal arc distortion. 43. Press the DISPLAY key twice to return to the normal screen.

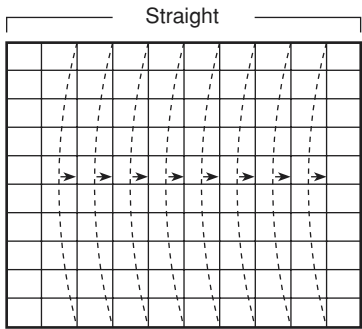

[COMPRESS (16 : 9) : ON, fv: 50Hz mode]

Item	Measuring instrument	Test point	Adjustment part	Description															
<p>Adjustment of V. HEIGHT</p>	<p>Signal generator Remote control unit</p>		<p>13. V. ZOOM 2. VER. HEIGHT</p>	<ol style="list-style-type: none"> 1. Receive a PAL cross-hatch signal of vertical frequency 50Hz. 2. Select COMPRESS from the MENU and set COMPRESS to ON. 3. Select 3. DEF from the SERVICE MENU. 4. Set the initial setting value of 13. V. ZOOM with the MENU </> key. 5. Select 2. VER. HEIGHT with the MENU ∇/△ key. 6. Set the initial setting value of 2. VER. HEIGHT with the MENU </> key. 7. Adjust 2. VER. HEIGHT to set the vertical amplitude of the image to 235mm. 															
					<p>Adjustment of SIDE PIN</p>	<p>Signal generator Remote control unit</p>		<p>7. EW-PIN</p>	<ol style="list-style-type: none"> 8. Select 7. EW-PIN with the MENU ∇/△ key. 9. Set the initial setting value of 7. EW-PIN with the MENU </> key. 10. Adjust 7. EW-PIN so that the first vertical lines at the left and right edges on the screen are straight. 						<p>Adjustment of CORNER</p>	<p>Signal generator Remote control unit</p>		<p>9. UP CORNER 10. DW CORNER</p>	<ol style="list-style-type: none"> 11. Select 9. UP CORNER with the MENU ∇/△ key. 12. Set the initial setting value of 9. UP CORNER with the MENU </> key. 13. Select 10. DW CORNER with the MENU ∇/△ key. 14. Set the initial setting value of 10. DW CORNER with the MENU </> key. 15. Adjust 9. UP CORNER and 10. DW CORNER so that the vertical lines at the four corners on the screen are straight. 16. Press the DISPLAY key twice to return to the normal screen.
<p>Adjustment of SIDE PIN</p>	<p>Signal generator Remote control unit</p>		<p>7. EW-PIN</p>	<ol style="list-style-type: none"> 8. Select 7. EW-PIN with the MENU ∇/△ key. 9. Set the initial setting value of 7. EW-PIN with the MENU </> key. 10. Adjust 7. EW-PIN so that the first vertical lines at the left and right edges on the screen are straight. 															
					<p>Adjustment of CORNER</p>	<p>Signal generator Remote control unit</p>		<p>9. UP CORNER 10. DW CORNER</p>	<ol style="list-style-type: none"> 11. Select 9. UP CORNER with the MENU ∇/△ key. 12. Set the initial setting value of 9. UP CORNER with the MENU </> key. 13. Select 10. DW CORNER with the MENU ∇/△ key. 14. Set the initial setting value of 10. DW CORNER with the MENU </> key. 15. Adjust 9. UP CORNER and 10. DW CORNER so that the vertical lines at the four corners on the screen are straight. 16. Press the DISPLAY key twice to return to the normal screen. 										
<p>Adjustment of CORNER</p>	<p>Signal generator Remote control unit</p>		<p>9. UP CORNER 10. DW CORNER</p>	<ol style="list-style-type: none"> 11. Select 9. UP CORNER with the MENU ∇/△ key. 12. Set the initial setting value of 9. UP CORNER with the MENU </> key. 13. Select 10. DW CORNER with the MENU ∇/△ key. 14. Set the initial setting value of 10. DW CORNER with the MENU </> key. 15. Adjust 9. UP CORNER and 10. DW CORNER so that the vertical lines at the four corners on the screen are straight. 16. Press the DISPLAY key twice to return to the normal screen. 															

[COMPRESS (16 : 9) : OFF, fv: 60Hz mode]

Item	Measuring instrument	Test point	Adjustment part	Description
Adjustment of V. SLOPE	Signal generator Remote control unit		1. VER. SLOPE	<ol style="list-style-type: none"> 1. Receive a NTSC circle pattern signal of vertical frequency 60Hz. 2. Select 3. DEF from the SERVICE MENU. 3. Select 1. VER. SLOPE with the MENU ∇/Δ key. 4. Set the initial setting value of 1. VER. SLOPE with the MENU \langle/ \rangle key. 5. Adjust 1. VER. SLOPE to make "A = B" with the MENU \langle/ \rangle key.
				<ol style="list-style-type: none"> 6. Select 3. VER. POSITION with the MENU ∇/Δ key. 7. Set the initial setting value of 3. VER. POSITION with the MENU \langle/ \rangle key. 8. Adjust 3. VER. POSITION to make "A = B" with the MENU \langle/ \rangle key. <p>(to be continued)</p>
Adjustment of V. POSITION	Signal generator Remote control unit		3. VER. POSITION	<p>(to be continued)</p>

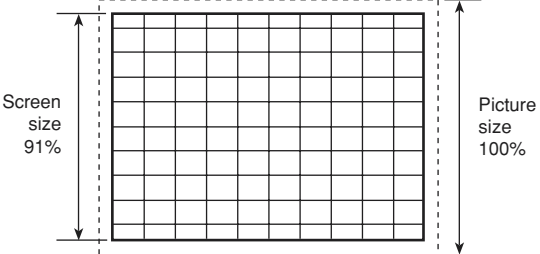
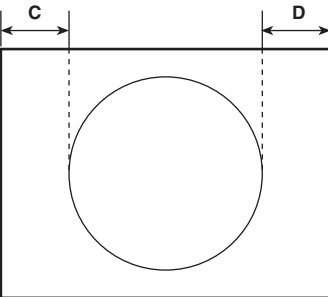
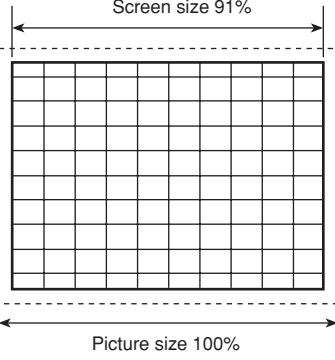
Item	Measuring instrument	Test point	Adjustment part	Description
Adjustment of V. HEIGHT	Signal generator Remote control unit		2. VER. HEIGHT 13. V. ZOOM	9. Receive a PAL cross-hatch signal. 10. Select 2. VER. HEIGHT with the MENU ∇/Δ key. 11. Set the initial setting value of 2. VER. HEIGHT with the MENU \langle/\rangle key. 12. Select 13. V. ZOOM with the MENU ∇/Δ key. 13. Set the initial setting value of 13. V. ZOOM with the MENU \langle/\rangle key. 14. Adjust 13. V. ZOOM and make the vertical screen size 91% of the picture size with the MENU \langle/\rangle key.
				Adjustment of H. POSITION
Adjustment of H. WIDTH	Signal generator Remote control unit		6. HOR. WIDTH	15. Receive a PAL circle pattern signal. 16. Select 5. HOR. POSITION with the MENU ∇/Δ key. 17. Set the initial setting value of 5. HOR. POSITION with the MENU \langle/\rangle key. 18. Adjust 5. HOR POSITION to make "C=D" with the MENU \langle/\rangle key.
				19. Receive a PAL cross-hatch signal. 20. Select 6. HOR. WIDTH with the MENU ∇/Δ key. 21. Set the initial setting value of 6. HOR. WIDTH with the MENU \langle/\rangle key. 22. Adjust 6. HOR. WIDTH and make the horizontal screen size 91% of the picture size with the MENU \langle/\rangle key.
				(to be continued)

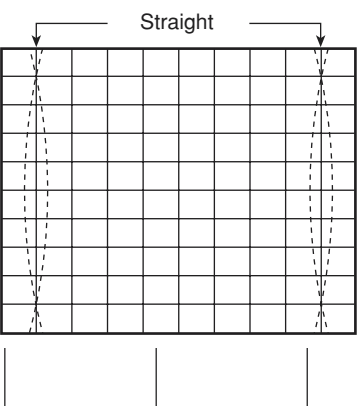
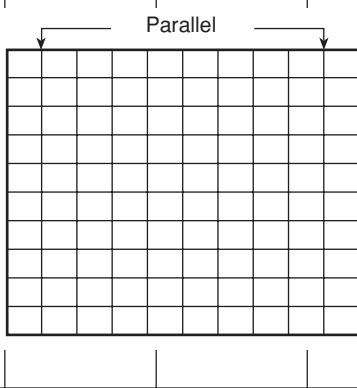
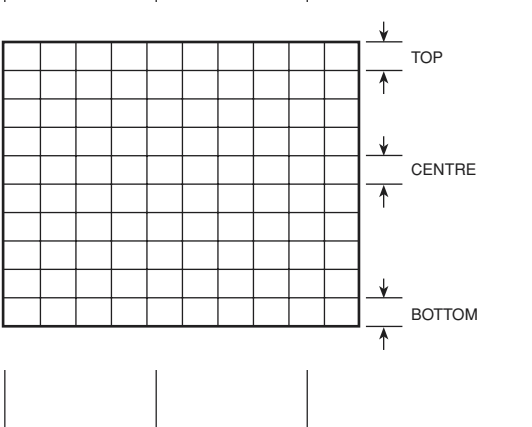
Item	Measuring instrument	Test point	Adjustment part	Description
Adjustment of SIDE PIN	Signal generator Remote control unit		7. EW-PIN	23. Select 7. EW-PIN with the MENU ∇/Δ key. 24. Set the initial setting value of 7. EW-PIN with the MENU \langle/\rangle key. 25. Adjust 7. EW-PIN so that the first vertical lines at the left and right edges on the screen are straight.
				
Adjustment of TRAPEZIUM	Signal generator Remote control unit		8. EW-TRAPEZ	26. Select 8. EW-TRAPEZ with the MENU ∇/Δ key. 27. Set the initial setting value of 8. EW-TRAPEZ with the MENU \langle/\rangle key. 28. Adjust 8. EW-TRAPEZ so that the vertical lines at the left and right edges on the screen are in parallel.
				
Adjustment of V.S-CURVE	Signal generator Remote control unit		4. VER. SCURVE	29. Select 4. VER. SCURVE with the MENU ∇/Δ key. 30. Set the initial setting value of 4. VER. SCURVE with the MENU \langle/\rangle key. 31. Adjust 4. VER. SCURVE so that the spaces of each line on TOP, CENTRE and BOTTOM become uniform. (to be continued)
				

Item	Measuring instrument	Test point	Adjustment part	Description
Adjustment of CORNER	Signal generator Remote control unit		9. UP CORNER 10. DW CORNER	32. Select 9. UP CORNER with the MENU ∇/Δ key. 33. Set the initial setting value of 9. UP CORNER with the MENU \langle/\rangle key. 34. Select 10. DW CORNER with the MENU ∇/Δ key. 35. Set the initial setting value of 10. DW CORNER with the MENU \langle/\rangle key. 36. Adjust 9. UP CORNER and 10. DW CORNER so that the vertical lines at the four corners on the screen are straight.
Adjustment of H. PARALLEL	Signal generator Remote control unit		11. HOR. PARALL	37. Select 11. HOR. PARALL with the MENU ∇/Δ key. 38. Set the initial setting value of 11. HOR. PARALL with the MENU \langle/\rangle key. 39. Adjust 11. HOR. PARALL to optimize the parallelogram distortion.
Adjustment of H. BOW	Signal generator Remote control unit		12. HOR. BOW	40. Select 12. HOR. BOW with the MENU ∇/Δ key. 41. Set the initial setting value of Select 12. HOR. BOW with the MENU \langle/\rangle key. 42. Adjust 12. HOR. BOW to optimize the horizontal arc distortion. 43. Press the DISPLAY key twice to return to the normal screen.

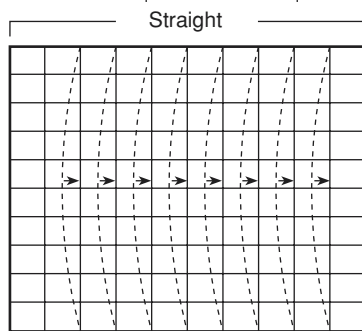

[COMPRESS (16 : 9) : ON, fV: 60Hz mode]

Item	Measuring instrument	Test point	Adjustment part	Description															
<p>Adjustment of V. HEIGHT</p>	<p>Signal generator Remote control unit</p>		<p>13. V. ZOOM 2. VER. HEIGHT</p>	<ol style="list-style-type: none"> 1. Receive a PAL cross-hatch signal of vertical frequency 60Hz. 2. Select COMPRESS from the MENU and set COMPRESS to ON. 3. Select 3. DEF from the SERVICE MENU. 4. Set the initial setting value of 13. V. ZOOM with the MENU </> key. 5. Select 2. VER. HEIGHT with the MENU ▽/△ key. 6. Set the initial setting value of 2. VER. HEIGHT with the MENU </> key. 7. Adjust 2. VER. HEIGHT to set the vertical amplitude of the image to 235mm. 															
					<p>Adjustment of SIDE PIN</p>	<p>Signal generator Remote control unit</p>		<p>7. EW-PIN</p>	<ol style="list-style-type: none"> 8. Select 7. EW-PIN with the MENU ▽/△ key. 9. Set the initial setting value of 7. EW-PIN with the MENU </> key. 10. Adjust 7. EW-PIN so that the first vertical lines at the left and right edges on the screen are straight. 						<p>Adjustment of CORNER</p>	<p>Signal generator Remote control unit</p>		<p>9. UP CORNER 10. DW CORNER</p>	<ol style="list-style-type: none"> 11. Select 9. UP CORNER with the MENU ▽/△ key. 12. Set the initial setting value of 9. UP CORNER with the MENU </> key. 13. Select 10. DW CORNER with the MENU ▽/△ key. 14. Set the initial setting value of 10. DW CORNER with the MENU </> key. 15. Adjust 9. UP CORNER and 10. DW CORNER so that the vertical lines at the four corners on the screen are straight. 16. Press the DISPLAY key twice to return to the normal screen.
<p>Adjustment of SIDE PIN</p>	<p>Signal generator Remote control unit</p>		<p>7. EW-PIN</p>	<ol style="list-style-type: none"> 8. Select 7. EW-PIN with the MENU ▽/△ key. 9. Set the initial setting value of 7. EW-PIN with the MENU </> key. 10. Adjust 7. EW-PIN so that the first vertical lines at the left and right edges on the screen are straight. 															
					<p>Adjustment of CORNER</p>	<p>Signal generator Remote control unit</p>		<p>9. UP CORNER 10. DW CORNER</p>	<ol style="list-style-type: none"> 11. Select 9. UP CORNER with the MENU ▽/△ key. 12. Set the initial setting value of 9. UP CORNER with the MENU </> key. 13. Select 10. DW CORNER with the MENU ▽/△ key. 14. Set the initial setting value of 10. DW CORNER with the MENU </> key. 15. Adjust 9. UP CORNER and 10. DW CORNER so that the vertical lines at the four corners on the screen are straight. 16. Press the DISPLAY key twice to return to the normal screen. 										
<p>Adjustment of CORNER</p>	<p>Signal generator Remote control unit</p>		<p>9. UP CORNER 10. DW CORNER</p>	<ol style="list-style-type: none"> 11. Select 9. UP CORNER with the MENU ▽/△ key. 12. Set the initial setting value of 9. UP CORNER with the MENU </> key. 13. Select 10. DW CORNER with the MENU ▽/△ key. 14. Set the initial setting value of 10. DW CORNER with the MENU </> key. 15. Adjust 9. UP CORNER and 10. DW CORNER so that the vertical lines at the four corners on the screen are straight. 16. Press the DISPLAY key twice to return to the normal screen. 															

[VIDEO - 2 SET : COMPONENT, fv: 50/60Hz mode]

Item	Measuring instrument	Test point	Adjustment part	Description
Adjustment of H. POSITION	Signal generator Remote control unit		5. HOR. POSITION	<ol style="list-style-type: none"> 1. Receive a PAL circle pattern signal to VIDEO-2 terminal. 2. Select VIDEO-2 SET from the MENU and set VIDEO-2 SET to COMPONENT. 3. Select 3. DEF from the SERVICE MENU. 4. Select 5. HOR. POSITION with the MENU ∇/Δ key. 5. Set the initial setting value of 5. HOR. POSITION with the MENU $\triangleleft/\triangleright$ key. 6 Adjust 5. HOR POSITION to make "C=D" with the MENU $\triangleleft/\triangleright$ key. 7. Press the DISPLAY key twice to return to the normal screen.

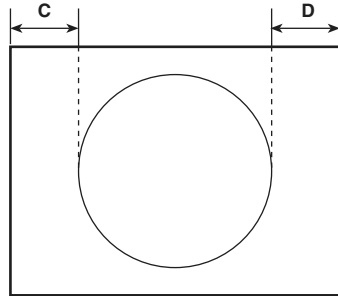

VSM PRESET SETTING

Item	Measuring instrument	Test point	Adjustment part	Description																								
Setting of VSM PRESET	Remote control unit		<ol style="list-style-type: none"> 1. TINT 2. COLOUR 3. BRIGHT 4. CONT 5. SHARP 	<ol style="list-style-type: none"> 1. Select 4. VSM PRESET from the SERVICE MENU. 2. Select BRIGHT with the PICTURE MODE key. 3. Adjust the MENU ∇/Δ key and MENU $\triangleleft/\triangleright$ key to reset the set values of 1. TINT – 5. SHARP to the values shown in the table. 4. Respectively select the VSM PRESET mode for SOFT and STANDARD, and make similar adjustment as in 3 above. 5. Press the DISPLAY key twice to return to the normal screen. <p>[Setting Values for SUB MENU 4. VSM PRESET]</p> <table border="1"> <thead> <tr> <th>VSM preset mode \ VSM Setting item</th> <th>BRIGHT</th> <th>STANDARD</th> <th>SOFT</th> </tr> </thead> <tbody> <tr> <td>1. TINT SETTING VALUE</td> <td>15</td> <td>←</td> <td>←</td> </tr> <tr> <td>2. COLOUR SETTING VALUE</td> <td>15</td> <td>←</td> <td>←</td> </tr> <tr> <td>3. BRIGHT SETTING VALUE</td> <td>15</td> <td>19</td> <td>←</td> </tr> <tr> <td>4. CONT SETTING VALUE</td> <td>30</td> <td>15</td> <td>11</td> </tr> <tr> <td>5. SHARP SETTING VALUE</td> <td>15</td> <td>←</td> <td>0</td> </tr> </tbody> </table>	VSM preset mode \ VSM Setting item	BRIGHT	STANDARD	SOFT	1. TINT SETTING VALUE	15	←	←	2. COLOUR SETTING VALUE	15	←	←	3. BRIGHT SETTING VALUE	15	19	←	4. CONT SETTING VALUE	30	15	11	5. SHARP SETTING VALUE	15	←	0
VSM preset mode \ VSM Setting item	BRIGHT	STANDARD	SOFT																									
1. TINT SETTING VALUE	15	←	←																									
2. COLOUR SETTING VALUE	15	←	←																									
3. BRIGHT SETTING VALUE	15	19	←																									
4. CONT SETTING VALUE	30	15	11																									
5. SHARP SETTING VALUE	15	←	0																									

SUB MENU 4. VSM PRESET

BRIGHT	
TINT	**
COLOUR	**
BRIGHT	**
CONT	**
SHARP	**
MENU $\blacktriangle/\blacktriangledown$: SELECT	
MENU $-/+$: OPERATE DISPLAY: EXIT	

PRESET SETTING

● Do not adjust 5. PRESET in the SERVICE MENU as it requires no adjustment.

[SUB MENU 5. PRESET]

	Setting item	Variable range	Initial setting value
1	PSNS	0/1	0
2	ACL	0/1	0
3	MUS	0/1	0
4	MAT	0/1	0
5	FCO	0/1	0
6	BPS	0/1	0
7	IFLH	0/1	0
8	VID	0/1	0
9	STM	0/1	0
10	AFCW	0/1	0
11	VSW	0/1	0
12	FFI	0/1	0
13	AGC	00/10/11	10
14	CL	50 – 95	83
15	AKB	0/1	0
16	HBL	0/1	0
17	BKS	0/1	1
18	READ STATUS	—	—
19	VNR	00 – 63	25
20	PEAK	0 – 3	0
21	IVG	0/1	1
22	WPL	0 – F	5
23	SOFT CLIPPER	0 – 3	0
24	IF PLL OFFSET	0 – 63	32
25	OVERSHOOT	0 – 3	3
26	HCO	0/1	0
27	HP2	0/1	0
28	AI VOLUME	00/01/10/11	01
29	SUB BASS 3D	–3 – +3	+2
30	SUB TREBLE 3D	–3 – +3	–2
31	CCCLOOP	–3 – +3	0

AUDIO ADJUSTMENT [AV-21WH3, AV-21WS3/AU only]

● Do not adjust 6. A2NICAM (1.ERROR LIMIT, 2.A2 ID THR, 3.SOUND SYSTEM) in the SERVICE MENU as it requires no adjustment.

[SUB MENU 6. A2NICAM]

Setting item	Variable range	Initial setting value (fixed)
1. ERROR LIMIT (Do not adjust.)	000H – FF0H	100H
2. A2 ID THR (Do not adjust.)	00H – FFH	0AH
3. SOUND SYSTEM (Do not adjust.)	—	—

PURITY ADJUSTMENT

Note: The final adjustment of CONVERGENCE must be done after the FOCUS adjustment. (CONVERGENCE is changed by FOCUS adjustment.)
 When makes difference by FOCUS adjustment, should be reconfirming PURITY adjustment.

1. Demagnetize CRT with the demagnetizer.
2. Loosen the retainer screw of the deflection yoke.
3. Remove the wedges.
4. Input a green raster signal from the signal generator, and turn the screen to green raster.
5. Move the deflection yoke backward.
6. Bring the long lug of the purity magnets on the short lug and position them horizontally. (Fig. 2)
7. Adjust the gap between two lugs so that the GREEN RASTER will come into the centre of the screen. (Fig. 3)
8. Move the deflection yoke forward, and fix the position of the deflection yoke so that the whole screen will become green.
9. Insert the wedge to the top side of the deflection yoke so that it will not move.
10. Input a crosshatch signal.
11. Verify that the screen is horizontal.
12. Input red and blue raster signals, and make sure that purity is properly adjusted.

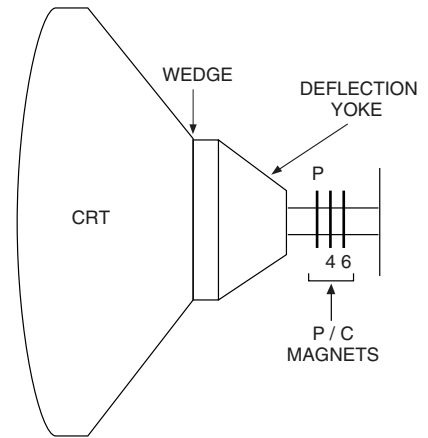

• P/C MAGNETS

P	: PURITY MAGNET
4	: 4 POLES (convergence magnets)
6	: 6 POLES (convergence magnets)

Fig. 1

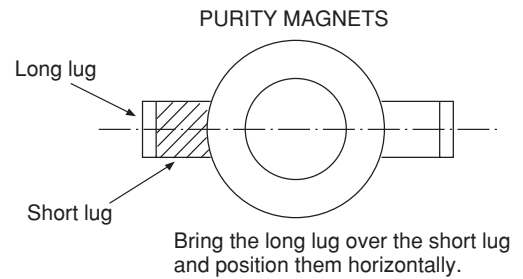

Fig. 2

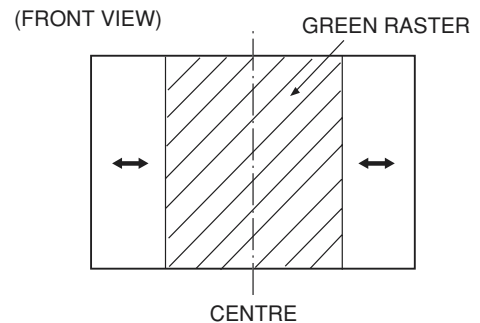

Fig. 3

CONVERGENCE ADJUSTMENTS

STATIC CONVERGENCE ADJUSTMENT

1. Input a crosshatch signal.
2. Using 4-pole convergence magnets, overlap the red and blue lines in the centre of the screen (Fig. 4) and turn them to magenta (red/blue).
3. Using 6-pole convergence magnets, overlap the magenta (red/blue) and green lines in the centre of the screen and turn them to white.
4. Repeat 2 and 3 above, and make best convergence.

DYNAMIC CONVERGENCE ADJUSTMENT

1. Move the deflection yoke up and down and overlap the lines in the periphery. (Fig. 5)
 2. Move the deflection yoke left to right and overlap the lines in the periphery. (Fig. 6)
 3. Repeat 1 and 2 above, and make best convergence.
 4. Adjust XV by XV coil. (Fig.7) (Fig.8)
- After adjustment, fix the wedge at the original position. Fasten the retainer screw of the deflection yoke. Fix the P/C magnets with glue.

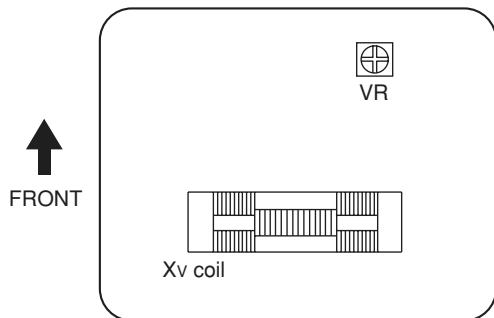

Fig. 8

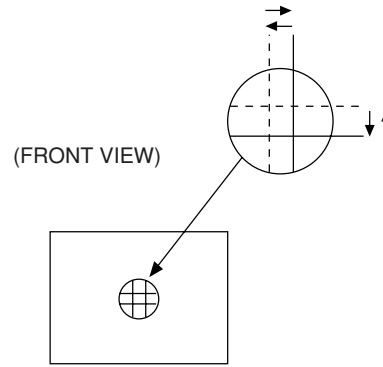

Fig. 4

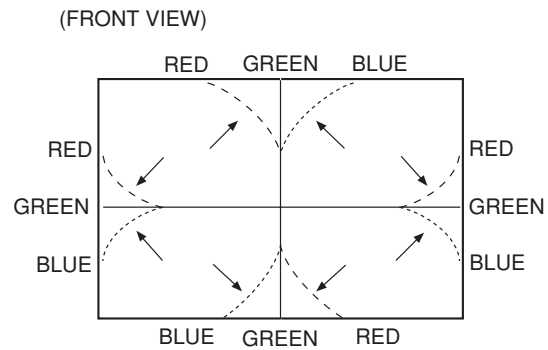

Fig. 5

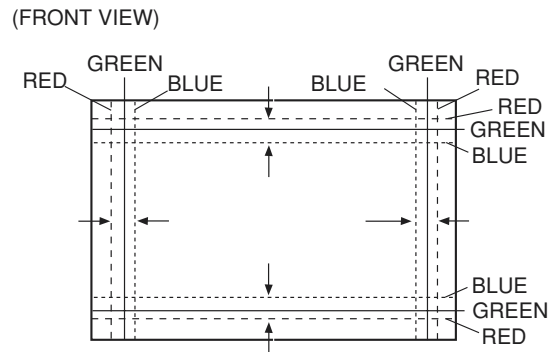

Fig. 6

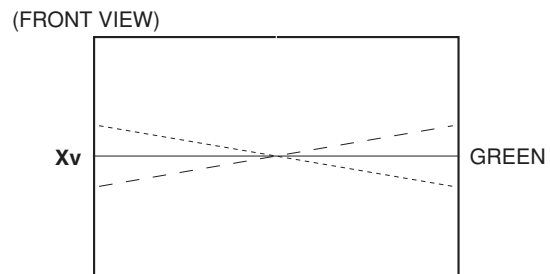

Fig. 7

SELF-CHECK FUNCTIONS

1. Outline

This model has self-check functions given below. When an abnormality has been detected, the SUB POWER is turned off and both ECO and ON TIMER LEDs flash to inform of the failure. An abnormality is detected by the signal input state of the control line connected to the microcomputer.

2. Self check items

Check item	Details of detection	Method of detection	State of abnormality
Over-current protection	An over-current on the low B line is detected.	The main microcomputer detects the possible abnormality at 30-msec.intervals and judges the results in every 16 time. Of the 16 times, if NG is detected more than 9 times, it is judged that there is an abnormality.	When an abnormality has been detected, the SUB-POWER is turned off. While the SUB-POWER is being turned off, the POWER key on the remote control unit is not operational until the power cord is taken out and put in again.
CRT NECK protection	Operation of CRT NECK protection circuit	DITTO	DITTO

3. Self check indicating function

When an abnormality has been detected at about 5 seconds after the power is turned on, the SUB POWER is turned off immediately and the LEDs flash.

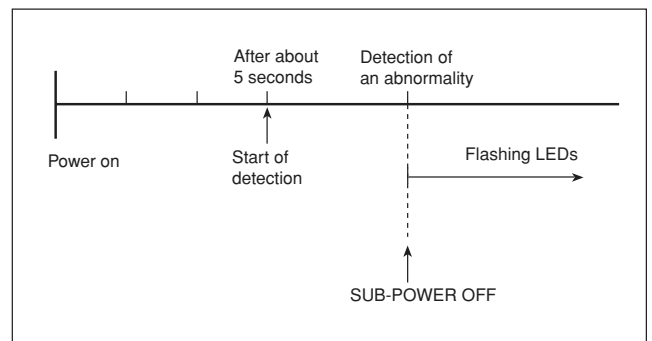

[Indication by the LEDs]

Item	LEDs flashing intervals	Priority of detection
① Over-current protection	At 0.2-second intervals	1
② CRT NECK protection	At 1-second intervals	2

Note: In case of ① + ②, the item ① is indicated.



JVC

VICTOR COMPANY OF JAPAN, LIMITED

HOME AV NETWORK BUSINESS UNIT 12, 3-chome, Moriya-cho, kanagawa-ku, Yokohama, kanagawa-prefecture, 221-8528, Japan

AV21WH3-H #4
AV21WS3AU-H #4
AV21WX3A-H #4
AV2178TEE-H #4



Printed in Japan
VP0208
SW